

# Sistemi Notte

## EN Night Systems

*Amateciems*  
Studija

PIANCA

# **Sistemi Notte**

## **EN Night Systems**

**PIANCA**

**PIANCA**

# Company Profile

Pianca è un importante marchio italiano nel settore di sistemi e complementi d'arredo per la casa, che si caratterizza per la ricerca di essenzialità ed un gusto elegante e sobrio. Ogni creazione, dagli armadi ai programmi per zona notte e per la zona giorno, alle librerie, ai tavoli, ai divani, fino alle sedie e agli accessori, viene ideata per essere personalizzabile in forme, misure e finiture. È una produzione articolata che unisce bellezza e creatività italiana alla libertà di “vestire su misura” la propria casa secondo i propri bisogni o esigenze.

## Origini

Da ben 14 generazioni la famiglia è specializzata nell'arte della falegnameria. La storia racconta che intorno al 1500, la famiglia detta “da Pianca” conduceva una rinomata falegnameria dotata di un mulino, alimentato da un corso d'acqua. L'arte ebanista venne tramandata di padre in figlio e molte sono le realizzazioni di pregio tuttora visibili in ville e chiese del trevigiano. A metà degli anni '50, Enrico Pianca trasforma l'attività da manifattura a industria, creando

Pianca is a major, well-known Italian industrial brand that produces furniture systems and accessories distinguished by an elegant, minimal and understated style. Each of our creations - including wardrobes, living and bedroom collections, bookshelves, tables, sofas, chairs and accessories – is designed to be customised in terms of shape, dimensions and finishes. Our extensive range of furniture is a perfect blend of Italian creativity and beauty, paired with the freedom to tailor your home to suit your needs and requirements.

## Origins

The Pianca family is specialised in the art of cabinet-making and can count on a tradition 14 generations long. In fact, history tells us that around 1500 a family called “da Pianca” used to manage a well-known carpenter's shop with a mill driven by a small stream. The art of cabinet-making was passed down from father to son and many prized artefacts in churches and villas of the Treviso province bear witness to this. In the mid-50s, Enrico Pianca transformed his business

le basi per uno sviluppo futuro. Pur investendo sulle più razionali concezioni produttive, egli non rinuncia alle competenze e professionalità acquisite nel tempo e mantiene all'interno della moderna azienda un reparto di lavorazioni strettamente manuali, dove il prof. Giovanni Battista Pianca, cugino-fratello di Enrico, guida una squadra di giovani ebanisti. Decide di progettare il sapere dei suoi operai ed artigiani nell'avveniristico mondo del design, che ancora non si chiama nemmeno così, ed è presente ininterrottamente fin dalla prima Edizione del Salone del Mobile di Milano dal 1961. Negli anni '80 il figlio Aldo subentra nella conduzione dell'azienda. Con lui la produzione si evolve in un sistema d'arredo completo mentre la distribuzione si espande ai mercati internazionali all'insegna di uno stile italiano moderno, funzionale ed elegante. Negli anni '90 Pianca implementa un modello di produzione sostenibile e flessibile con servizio "just in time" per sistemi d'arredo che garantiscono molteplici possibilità compositive personalizzabili su misura.

### **Made In Italy**

Il nostro essere italiani è garanzia di qualità universalmente riconosciuta e lo viviamo come un marchio da tutelare. A garanzia della massima qualità, Pianca sceglie fornitori italiani e realizza internamente tutte le fasi della produzione. Dalla Marca esportiamo nel mondo l'eleganza e il pregio delle lavorazioni Made in Italy.

### **Design**

La ricerca del design Pianca si rinnova con costanza e coerenza, al fine di rispondere alle esigenze del vivere moderno e soddisfare il gusto contemporaneo in continua

from a cabinet maker's workshop to a full-blown factory, creating the basis for future development. Although he invested in the most rational productive systems, he didn't want to give up the expertise and skills gained over time and decided to dedicate a section of the factory to handcrafted creations, where Giovanni Battista Pianca, Enrico's cousin, lead a team of young cabinet makers. Enrico then decided to project the knowledge of his trusted workers and artisans into the futuristic world of design (it wasn't even known by that name yet!) and started to present his products at every Salone del Mobile in Milan from the very first edition in 1961. In the 80s, Aldo - Enrico Pianca's son - took the helm of the company. With him, production grew and developed into a complete furnishing system while distribution expanded to international markets, all in the name of a modern, functional and elegant Italian style. In the 90s, Pianca introduced a flexible and sustainable "just in time" production model to deliver highly customisable furnishing systems tailored to suit any taste or requirement.

### **Made In Italy**

The fact that we are Italian is a universally recognised guarantee of quality, and we see it as a hallmark to be safeguarded. To guarantee the best possible quality, Pianca chooses Italian suppliers and performs each step of the production process inside its production plant. From our region we export the elegance and luxury of Italian-made products across the globe.

### **Design**

Pianca's design is constantly and consistently renewing itself to satisfy the needs of modern



1956 Enrico Pianca trasforma la storica attività manifatturiera in industria, <sup>EN</sup> 1956 Enrico Pianca transforms a carpenter shop into a factory



1970 Europremio dell'arredamento per l'alta qualità dei prodotti - Palazzo dei Congressi Roma, <sup>EN</sup> 1970 Europremio prize for high-quality furniture - Palazzo dei Congressi, Rome

evoluzione, mantenendo essenzialità, sobrietà ed eleganza, valori che caratterizzano ogni prodotto e rendono riconoscibile lo stile Pianca.

### Savoir Faire

La nostra azienda è fatta prima di tutto di persone. Il loro immenso valore è il nostro primo capitale, un bagaglio di conoscenze e abilità che solo l'esperienza fa conquistare nel tempo. C'è il gusto di Marta dietro la scelta dei legni, la perizia di Luca a garantire la perfezione delle laccature, l'occhio attento di Giacomo al controllo qualità. Per noi è così da sempre. Produciamo design, ma usiamo ancora le mani, e ci sentiamo sempre artigiani.

### Sostenibilità

Pianca fa uso di legno ecosostenibile, proveniente da boschi certificati a prelievo controllato contro la deforestazione e di pannelli esenti da colle tossiche. Siamo stati i primi a impiegare le laccature lucide ad acqua per la salute dei nostri dipendenti e per abbattere l'inquinamento domestico. Gli scarti di lavorazione vengono riutilizzati in caldaie per produrre energia termica, l'impiego di pannelli fotovoltaici producono un Megawatt di energia elettrica, mentre i sistemi di imballaggio sono al 100% automatizzati e riciclabili, tanto che anche Amazon, l'azienda americana di commercio elettronico, nel 2014 ha voluto visitare Pianca per capire i segreti del suo imballaggio d'avanguardia.

### Customer Care

Ci affidiamo a un selezionato network di rivenditori formati, in grado di fornire massime garanzie di qualità, assistendo il

lifestyles and ever-changing contemporary tastes while preserving the minimalism, understatement and elegance that have become its hallmark and are typical values of all its products.

### Savoir Faire

First and foremost, our company is made of people. Their immense value is our greatest asset, with their wealth of knowledge and skills that only time and experience can bring. Marta's taste lies behind the choice of wood species, Luca's expertise guarantees the perfection of lacquers, Giacomo's careful eye ensures rigorous quality control. That's the way it's always been here at Pianca. We produce design, but we still use our hands, and we still consider ourselves craftsmen, and women.

### Sustainability

Pianca uses eco-friendly wood sourced from certified forests with controlled harvesting to limit deforestation. Our panels are free from toxic adhesives. We were the first to use water-based gloss lacquers to protect the health of our employees and reduce pollution in the home. Off-cuts are burnt in special furnaces to produce energy, solar panels produce about 1 Megawatt of electric power and our packaging systems are 100% automatic and recyclable so that even Amazon, the American e-commerce company, visited Pianca in 2014 to uncover the secret of its cutting-edge packaging system.

### Customer Care

We entrust our products to a selected network of trained retailers who offer the

cliente dalla progettazione al montaggio, garantendo disponibilità e cortesia nel servizio post vendita. Con questi negozi instauriamo un rapporto di partnership, ci confrontiamo quotidianamente per rispondere alle loro esigenze e creare l'arredamento su misura per l'acquirente finale, garantendo una casa di design che risponda ai gusti e alle necessità di chi la abita.

highest guarantees of quality, assistance and courtesy, from planning to delivery and final assembly. We keep in touch with them on a daily basis, to satisfy their needs and create customised furniture for end customers, guaranteeing homes furnished with design products that reflect the tastes and requirements of their householders.

### Pianca in the World

Albania	Guernsey	Poland	United States
Andorra	Hong Kong	Portugal	Venezuela
Australia	Hungary	Puerto Rico	Vietnam
Austria	India	Qatar	
Azerbaijan	Indonesia	Romania	
Bahrein	Israel	Russia	
Belgium	Italy	Salvador	
Bielorussia	Kazakhstan	Saint-Barthélemy	
Bulgaria	Korea	San Marino	
Canada	Kuwait	Serbia	
China	Latvia	Seychelles	
Cyprus	Lebanon	Singapore	
Czech Republic	Libya	Slovakia	
Colombia	Lithuania	Slovenia	
Costa Rica	Luxembourg	South Africa	
Croatia	Macedonia	Spain	
Ecuador	Malaysia	Switzerland	
Egypt	Malta	Taiwan	
Estonia	Morocco	Thailand	
France	Mexico	Turkey	
Georgia	Nigeria	Ukraine	
Germany	Netherlands	United Arab Emirates	
Greece	Panama	United Kingdom	

**Qualità, funzionalità, versatilità. Valica i confini della camera da letto la collezione di armadi e cabine Pianca, progettata per organizzare qualunque ambiente della casa, area living, cucina e spazi di servizio compresi, anche di ridotte dimensioni. Variegata ed elegante, presenta dettagli ricercati, vasta modularità e lavorazioni su misura, oltre ad un'ampia selezione di finiture da combinare e di attrezzature interne da comporre in base ai propri gusti ed alle proprie esigenze.**

**<sup>EN</sup> Quality, functionality and versatility. Pianca's collection of wardrobes and walk-in closets go beyond the boundaries of the bedroom because they have been designed to organise any room in the home including the living room, kitchen and utility rooms, no matter how small. Very varied and elegant, with refined details, a vast range of module sizes and custom-sized units, this collection boasts a wide selection of finishes that can be mixed and matched and interior accessories that can be chosen to suit individual tastes and needs.**

**PIANCA**

# Indice

## <sup>EN</sup> Index

### **Ante incorniciate** <sup>EN</sup> **Doors with frame**

Vitrum 19, 240  
Milano 31, 230  
Cornice 45, 222

### **Ante lineari** <sup>EN</sup> **Plain doors**

Plana 63, 242  
Nastro 75, 232  
Icona 87, 226  
Tratto 99, 236  
Manhattan 109, 228

### **Ante decorate** <sup>EN</sup> **Decorated doors**

Raggio 121, 234  
Vela 133, 238  
Crea 143, 224

### **Cabine armadio** <sup>EN</sup> **Walk-in closet**

Anteprima 155, 304  
Sipario 183, 300  
Island 162, 204, 324  
Snake 58, 328  
Vista 160, 166, 169, 189, 330

# Info Tecniche

## <sup>EN</sup> Technical info

### **Armadi** <sup>EN</sup> Wardrobes

Struttura, <sup>EN</sup> Structure 210  
Finiture interne, <sup>EN</sup> Internal finishes 212  
Tipologia apertura, <sup>EN</sup> Opening types 214  
Modularità, <sup>EN</sup> Modularity 216  
Moduli speciali, <sup>EN</sup> Special modules 218

### **Collezione ante** <sup>EN</sup> Doors collection

Cornice, Crea, Icona, Manhattan, Milano, Nastro,  
Raggio, Tratto, Vela, Vitrum, Plana 221

### **Moduli speciali** <sup>EN</sup> Special modules

Stagionale, <sup>EN</sup> Seasonal module 248  
Per elettrodomestici, <sup>EN</sup> For household appliances 249  
Con cassetiera esterna, <sup>EN</sup> With external drawer units 250  
Con vano a giorno, <sup>EN</sup> With open element 251  
Sovraporta, <sup>EN</sup> Over door module 252  
Ponte, <sup>EN</sup> Bridge module 253  
Modulo TV, <sup>EN</sup> TV module 254  
Angolari, <sup>EN</sup> Corners 255  
Cabina soffietto, <sup>EN</sup> Folding door dressing closet 258  
Terminali, <sup>EN</sup> Terminal modules 260  
Pannelli per modulo centrostanza, <sup>EN</sup> Panels for  
all-side finished module 262

### **Attrezzature** <sup>EN</sup> Accessories

Ripiani, <sup>EN</sup> Shelves 266  
Divisori interni, <sup>EN</sup> Internal partitions 267  
Cassettiere, <sup>EN</sup> Drawer units 268  
Appenderia, <sup>EN</sup> Hangers 276  
Telai estraibili e accessori, <sup>EN</sup> Pull-out frames and  
accessories 278  
Accessori, <sup>EN</sup> Accessories 284  
Specchi, <sup>EN</sup> Mirrors 286  
Illuminazione, <sup>EN</sup> Lighting 287  
Allestimenti interni, <sup>EN</sup> Interior configurations 288

### **Lavorazioni su misura** <sup>EN</sup> Made to measure solutions

Altezza, <sup>EN</sup> Height 292  
Larghezza, <sup>EN</sup> Width 293  
Profondità, <sup>EN</sup> Depth 294  
Tamponamenti, <sup>EN</sup> Fillers 296

### **Cabine armadio** <sup>EN</sup> Walk-in closet

Sipario, Anteprema 300, 304

### **Complementi cabine** <sup>EN</sup> Walk-in closet complements

Island, Snake, Vista 324, 328, 330

# Indice Armadi e Cabine

## EN Wardrobes and Walk-in closet index



**Cornice**  
Photogallery 45  
Technical information 222



**Crea**  
Photogallery 143  
Technical information 224



**Icona**  
Photogallery 87  
Technical information 226

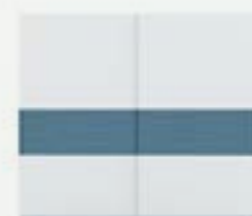

**Vela**  
Photogallery 133  
Technical information 238



**Vitrum**  
Photogallery 19  
Technical information 240



**Vista**  
Photogallery 160, 166, 169, 189  
Technical information 330



**Manhattan**  
Photogallery 109  
Technical information 228



**Milano**  
Photogallery 31  
Technical information 230



**Nastro**  
Photogallery 75  
Technical information 232



**Anteprema**  
Photogallery 155  
Technical information 304



**Sipario**  
Photogallery 183  
Technical information 300



**Plana**  
Photogallery 63  
Technical information 242



**Raggio**  
Photogallery 121  
Technical information 234



**Tratto**  
Photogallery 99  
Technical information 236



**Island**  
Photogallery 162, 204  
Technical information 324



**Snake**  
Photogallery 58  
Technical information 328

**Ante incorniciate**  
**<sup>EN</sup> Doors with frame**



PIANCA

Sistemi Notte  
<sup>EN</sup> Night Systems

Designer  
Pianca Studio

# Vitrum

**Vitrum**  
Technical Information  
on p. 240

Il vetro rivela, riflette, crea un'affascinante compenetrazione tra interno ed esterno. A modulare questo dialogo è il vetro delle ante, disponibile nella versione Traspirente Extrachiaro, Fumé Traspirente o Satinato, Stop Sol, e nei tre colori dei vetri serigrafati Trama: caratteristiche estetiche differenti per ogni grado di trasparenza. L'anta è serigrafata con un'intrigante cornice nera. Alta e sottile, la maniglia a lama inclinata è realizzata in alluminio anodizzato nero, come il telaio, discreta e maneggevole sia con apertura a battente che scorrevole.

<sup>EN</sup> Glass reveals, reflects and mingles the inside with the outside in the most fascinating of ways. The mediator of this dialogue is the glass door panel, in Extraclear Transparent, Transparent or Satin Fumé and Stop Sol finishes and in the three colours available for Trama screen-printed glass: different aesthetic features for varying degrees of transparency. The door sports an intriguing, black, screen-printed frame. The long, slim, inclined handle is made from black anodised aluminium matching the frame and is discreet and handy on both hinged and sliding doors.

*In questo ambiente:* **Vitrum** armadio scorrevole vetro Fumé Traspirente, interno materico Canaletto. **Esse Lounge** poltrona in tessuto Rico 32 con gambe Canaletto.

<sup>EN</sup> *In this setting:* **Vitrum** sliding door wardrobe in transparent Fumé glass, interior in Canaletto materico. **Esse Lounge** armchair in Rico 32 fabric with Canaletto legs.





Cassettiera materico Canaletto con frontali ed accessori interni in pelle sintetica Elephant. Ripiano in pelle sintetica Elephant con bordo materico Canaletto.

<sup>EN</sup> Drawer unit in Canaletto materico with fronts and internal accessories in Elephant synthetic leather Shelf covered in Elephant synthetic leather with edging in Canaletto materico.



**Vitrum** armadio centrostanza con pannello di finitura posteriore Canaletto. **Boiserie** Canaletto con distanziali Titanio, **Rialto** tatami in tessuto Taigal 23 con distanziali Titanio, **Chloé** comodino in tessuto Moritz 52 e laccato opaco Lavagna.

<sup>EN</sup> **Vitrum** back-finished wardrobe with Canaletto finishing back panel. **Wall panels** Canaletto with Titanio spacers, **Rialto** platform bed in Taigal 23 fabric with Titanio spacers, **Chloé** night table in Moritz 52 fabric and Lavagna matt lacquer.

*In questo ambiente:* **Vitrum** armadio battente vetro Stopsol, interno e cassettiere laccato opaco Lavagna, schienale materico Gioia di Carrara e **Plana** armadio battente laccato opaco Lavagna. **Eden** poltrona e pouf in pelle Lord 85.

<sup>EN</sup> *In this setting:* **Vitrum** hinged door wardrobe in Stopsol glass, interior and drawers unit in Lavagna matt lacquer, back panel in Gioia di Carrara materico and **Plana** hinged door wardrobe in Lavagna matt lacquer. **Eden** armchair and ottoman in Lord 85 leather.







PIANCA

Sistemi Notte  
<sup>EN</sup> Night Systems

Designer  
Pianca Studio

# Milano

**Milano**  
Technical Information  
on p. 230

Come in una boutique personale, i propri oggetti e i propri capi di abbigliamento diventano elementi da valorizzare, da esporre con eleganza ed ordine. Le ante in vetro, definite da un telaio verniciato in finitura Canna di Fucile o Silicio enfatizzano ed impreziosiscono le composizioni. Le attrezzature interne a vista dimostrano grande capacità di organizzare con efficacia e raffinatezza lo spazio. Speciale è anche l'apertura a battente delle ante, che può raggiungere un angolo di 180°, con cerniere a perno.

<sup>EN</sup> Just as if they were arranged in a personal boutique, your objects and garments must be enhanced and exhibited with elegance and order. The glass doors, defined by a Gunmetal Grey or metallized brown frame, set off and add a finishing touch to arrangements. The visible interior accessories show off their great ability to efficiently organise spaces with style. The hinged doors come with special pivot hinges that can open at a 180° angle.

*In questo ambiente:* **Milano** armadio battente vetro Trama Bronzo con telaio Canna di Fucile, interno materico Borgogna e laccato opaco Ral, **Plana** armadio battente Borgogna. **Eden** pouf capitonné in tessuto Sweet 33, **Mono** tavolo in pelle Lord 89, **Esse** poltrona in tessuto Amalfi 31. Tappeto Apollo Ciliegia.

<sup>EN</sup> *In this setting:* **Milano** hinged door wardrobe in Trama Bronzo glass with Gunmetal Grey frame, interior in Borgogna materico and Ral matt lacquer, **Plana** hinged door wardrobe in Borgogna. **Eden** tufted ottoman in Sweet 33 fabric, **Mono** table in Lord 89 leather, **Esse** armchair in Amalfi 31 fabric. Carpet Apollo Ciliegia.





Modulo con ante battenti vetro Trama Bronzo, ripiani portascarpe materico Borgogna, schiena laccato opaco Ral e luce a led. Anta **Milano** con telaio Canna di Fucile.



<sup>EN</sup> Module with hinged doors in Trama Bronzo glass, shoe shelves in Borgogna materico, back panel in Ral matt lacquer and LED light. **Milano** door with Gunmetal Grey frame.



**Mono** tavolo in pelle Lord 89, **Esse** poltrona in tessuto Amalfi 31. Portagonne estraibile con telaio Manganese e frontale materico Borgogna.

<sup>EN</sup> **Mono** table in Lord 89 leather, **Esse** armchair in Amalfi 31 fabric. Extractible skirt hanger with Manganese frame and front in Borgogna materico.

*In questo ambiente:* **Milano** armadio battente vetro trasparente Extrachiaro, con telaio Canna di Fucile, interno materico Borgogna e laccato opaco Cioccolato, luce led. **Dioniso** letto Rovere Grigio e pelle Softy 64, **Dedalo** comodino Rovere Grigio con top in pietra Multicolor. Tappeto Teseo Talpa.

<sup>EN</sup> *In this setting:* **Milano** hinged door wardrobe in Extra clear transparent glass, with Gunmetal Grey frame, interior in Borgogna materico and Cioccolato matt lacquered, LED light. **Dioniso** bed in Rovere Grigio and Softy 64 leather, **Dedalo** night table in Rovere Grigio and top in Multicolor slate. Carpet Teseo Talpa.





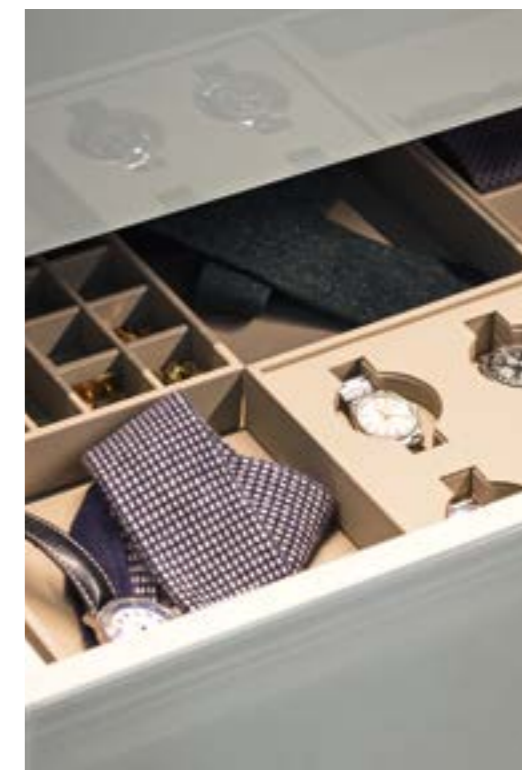

*In questo ambiente:* **Milano** armadio con ripiani e cassettiere laccato opaco Cioccolato e schienale in materico Borgogna. Accessori per interno cassetto in pelle sintetica Creta.

*EN In this setting:* **Milano** wardrobe with shelves and drawer units in Cioccolato matt lacquer and back panel in Borgogna materico. Accessories for drawer interior in Creta synthetic leather.

PIANCA

Sistemi Notte  
<sup>EN</sup> Night Systems

Designer  
Pianca Studio

# Cornice

**Cornice**  
Technical Information  
on p. 222

Il tratto sottile e continuo del telaio disegna un profilo discreto ed essenziale. In alluminio laccato o anodizzato nero, ritma la successione di elementi verticali, oppure tende a mimetizzarsi se coordinato alla superficie delle ante, disponibili in vetro laccato, specchio, essenza, materico, pelle sintetica e laccate. Longilinea e leggermente angolata, la maniglia nasce come naturale continuazione del telaio, garantendo un'immagine elegante e lineare, e un'ottima prensilità per ogni tipologia di anta, a battente, scorrevole o complanare.

<sup>EN</sup> The slim, uninterrupted line of the frame draws a discreet and minimal outline. In lacquered or black anodized aluminium, it punctuates the run of vertical modules or tends to blend in when coordinated with the surface finish of the doors available in lacquered glass, mirror, wood and textured finishes as well as man-made leather and matt or gloss lacquers. Long and slightly angled, the handle is designed to form a line that carries on from the frame, giving the door an elegant, linear appeal and offering an excellent grip to any type of hinged, sliding and flush sliding door.

*In questo ambiente:* **Cornice** armadio battente in pelle sintetica Talpa, interno materico Borgogna, cassettera con frontali oblò vetro Fumé. **Oplà** poltrona in tessuto Sweet 33.

<sup>EN</sup> *In this setting:* **Cornice** hinged door wardrobe in Talpa synthetic leather interior in Borgogna materico, drawer unit with Fumé glass fronts. **Oplà** armchair in Sweet 33 fabric.





**Cornice** armadio in pelle sintetica Talpa con modulo terminale a scrigno, ripiani materico Borgogna e luce led verticale.

**Cornice** wardrobe in Talpa synthetic leather with terminal module with L-shaped opening, shelves in Borgogna materico and vertical LED light.

*In questo ambiente:* **Cornice** armadio scorrevole vetro Metallizzato Bronzo, interno materico Perlage Terra e ripiani vetro Fumé. **Cubo** pouf in pelle Polo 18, **Mono** tavolo Corten, **Gamma** sedia in tessuto Gaucho 51 con basamento tubolare Borgogna, **People** comò Borgogna con distanziali Bronzo.

<sup>EN</sup> *In this setting:* **Cornice** sliding door wardrobe in glass Metallizzato Bronzo, interior in Perlage Terra materico and shelves in Fumé glass. **Cubo** ottoman in Polo 18 leather, **Mono** table in Corten, **Gamma** chair in Gaucho 51 fabric with tubular base in Borgogna, **People** dresser in Borgogna with Bronzo spacers.





*In questo ambiente:* **Cornice** armadio complanare specchio Piombo, interno laccato opaco Melograno. **Esse Lounge** poltrona in tessuto Positano 51.

*In this setting:* **Cornice** flush-sliding door wardrobe in Piombo mirror, interior in Melograno matt lacquer. **Esse Lounge** armchair in Positano 51 fabric.





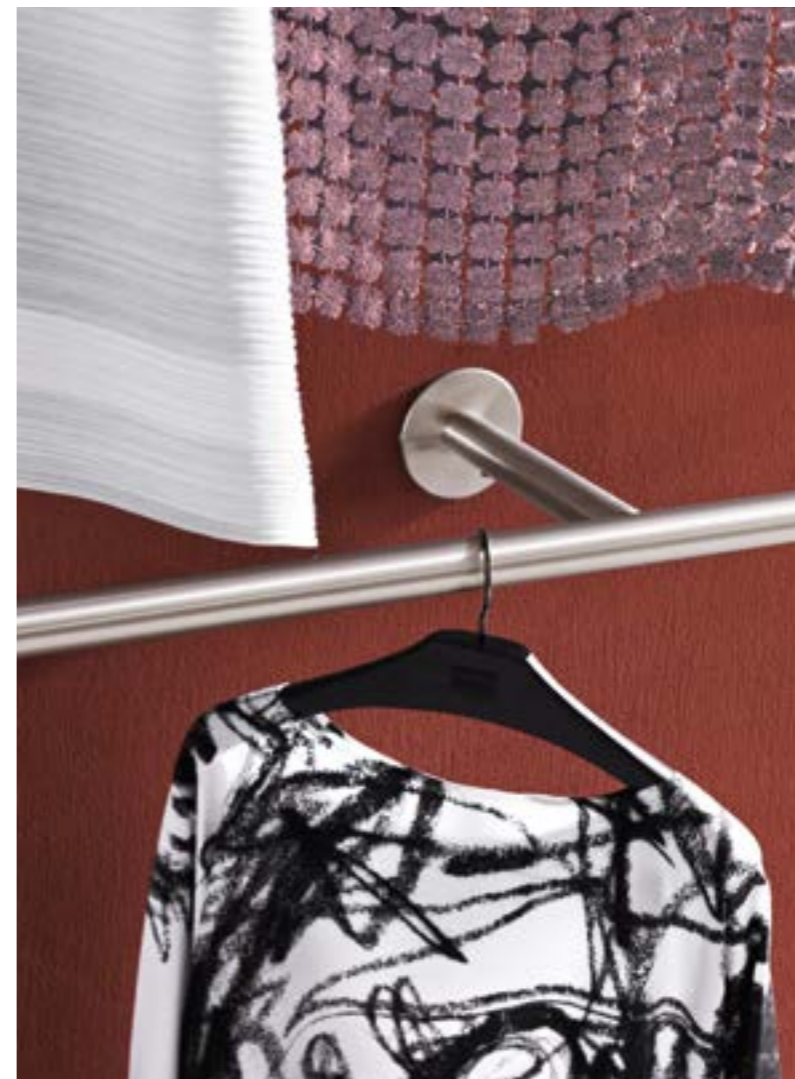

**Snake** composizione appendiabiti a parete in acciaio spazzolato. Aste e connessioni a passo 14 cm danno la possibilità di creare qualsiasi disegno a parete. Tappeto Apollo Ciliegia.

<sup>EN</sup> **Snake** wall composition in sanded steel. Beams and connections with their 14 cm pace allow to create any kind of wall composition. Carpet Apollo Ciliegia.

**Ante lineari**  
**EN Plain doors**



PIANCA

Sistemi Notte  
EN Night Systems

Designer  
**Pianca Studio**

# Plana

**Plana**  
Technical Information  
on p. 242

Essenzialità e versatilità si traducono in libertà di personalizzare ed arredare. Ante semplici, lineari, disponibili laccate, in essenza o materico, completate da una vasta scelta di maniglie da abbinare all'apertura, a battente, scorrevole o complanare. Risolvere soluzioni è nell'indole di Plana, che mette a disposizione anche moduli speciali: stagionale, sovrapporta, ponte con scrittoio o con tv, cassetiera esterna, per elettrodomestici, con moduli a giorno, terminale, cabina a soffietto. A richiesta anche lavorazioni su misura, per inserire la struttura in qualsiasi spazio.

EN Minimalism and versatility become freedom to customise and furnish. Simple, linear doors are available lacquered, in wood or textured, completed by a vast range of handles to pair with hinged, sliding and flush sliding doors. Problem-solving comes naturally to Plana that is also available in special modules: four-season units, over door modules, bridging modules with a desk or TV, modules with external drawer units, household appliances, with open modules, terminal modules and walk-in closets with folding doors. Custom-sized modules that can be fitted in any kind of space are also available.

*In questo ambiente:* **Plana** armadio complanare materico Corsica e maniglia Rame. **Esse Lounge** poltrona in tessuto Moritz 51 con gambe laccato opaco Lavagna.

EN *In this setting:* **Plana** flush-sliding door wardrobe in Corsica materico and Rame handle. **Esse Lounge** armchair in Moritz 51 fabric with legs in Lavagna matt lacquer.



*In questo ambiente:* **Plana** armadio battente Canaletto con apertura push-pull e moduli a giorno laccato opaco Nuvola. **Calatea** poltrona in pelle Softy 62 con gambe laccato opaco Lavagna, elemento **Spazio** in laccato opaco Lavagna.

<sup>EN</sup> *In this setting:* **Plana** hinged door wardrobe in Canaletto, with push pull opening and open modules in Nuvola matt lacquer. **Calatea** armchair in Softy 62 leather with legs in Lavagna matt lacquer, **Spazio** element in Lavagna matt lacquer.





*In questo ambiente:* **Plana** armadio scorrevole laccato lucido Cappuccino, interno materico Borgogna. **Trama Intreccio** letto in pelle Vintage 33, **Servogiro** tavolino laccato opaco Lavagna. Tappeto Teseo Terra.

<sup>EN</sup> *In this setting:* **Plana** sliding door wardrobe in Cappuccino high-gloss lacquer, interior in Borgogna materico. **Trama Intreccio** bed in Vintage 33 leather, **Servogiro** side table in Lavagna matt lacquer. Carpet Teseo Terra.





PIANCA

Sistemi Notte  
<sup>EN</sup> Night Systems

Designer  
Pianca Studio

# Nastro

**Nastro**  
Technical Information  
on p. 232

Lo stile sobrio e delicato della semplicità incontra la massima possibilità di espressione e personalizzazione. Per soddisfare qualunque esigenza estetica e funzionale, Nastro offre una vasta gamma di finiture e soluzioni speciali: cassettera esterna, modulo a ponte, sovrapporta, tv, terminale a giorno oltre alle lavorazioni su misura. Incassate nelle ante, le maniglie in alluminio a tutta altezza delineano gole dai colori laccati o dalle brillanti finiture metalliche.

<sup>EN</sup> The understated and delicate style of simplicity meets the ultimate in expressiveness and customisation. Nastro offers a vast range of finishes and special solutions to satisfy any aesthetic or functional request: external drawer unit module, bridging module, unit installed above doors, TV unit, open end unit as well as custom-sized solutions. Recessed in the doors, the aluminium, full-height handles draw channels in lacquered colours or in shiny metal finishes.

*In questo ambiente:* **Nastro** armadio battente con cassetti esterni e modulo ponte Borgogna, maniglia Oro. **Gamma** sedia in tessuto Velvet 44 con traliccio Oro.

<sup>EN</sup> *In this setting:* **Nastro** hinged door wardrobe with external drawers and Borgogna bridge module, Oro handle. **Gamma** chair in Velvet 44 fabric with Oro pylon base.





**Nastro** armadio con modulo ponte Borgogna e **Ala** scrittoio.  
**Gamma** sedia in tessuto Velvet 44 con traliccio Oro.

<sup>EN</sup> **Nastro** wardrobe with Borgogna bridge module and **Ala** desk.  
**Gamma** chair in Velvet 44 fabric with Oro pylon base.

*In questo ambiente:* **Nastro** armadio scorrevole con terminale a giorno attrezzato con ripiani laccato opaco Seta e asta appendiabiti Manganese. **Abaco** tavolino Rame.

*EN In this setting:* **Nastro** sliding door wardrobe with open terminal module equipped with shelves in Seta matt lacquer and hanger in Manganese. **Abaco** side table in Rame.





**Nastro** armadio con interno laccato opaco Seta, elemento a T, luce led orizzontale. Terminale a giorno con asta appendiabiti Manganese.

<sup>EN</sup> **Nastro** wardrobe with interior in Seta matt lacquer, T-shaped element, horizontal LED light. Open terminal module with Manganese hanger.

*In questo ambiente:* **Nastro** armadio complanare vetro laccato opaco Lavagna, interno laccato opaco Argilla. **Rialto Large** letto in pelle Nabuk 41 e distanziali Borgogna, **Haik** tavolino Argento.

*EN In this setting:* **Nastro** flush-sliding door wardrobe in Lavagna matt lacquered glass, interior in Argilla matt lacquer. **Rialto Large** bed in Nabuk 41 leather and Borgogna spacers, **Haik** side table in Argento.





PIANCA

Sistemi Notte  
<sup>EN</sup> Night Systems

Designer  
**Pianca Studio**

# Icona

**Icona**  
Technical Information  
on p. 226

Design lineare e versatile dai dettagli sofisticati. Icona si veste di personalità attraverso il connubio tra sobrietà ed espressività. Incassata nel pannello in legno, orizzontale o verticale, la maniglia rappresenta un elemento distintivo e raffinato, da personalizzare in base al proprio gusto: con colori laccati vivaci o più neutri, con finiture metalliche classiche o più eccentriche. Laccate, in essenza o materico, le ante hanno apertura a battente, scorrevole o complanare.

<sup>EN</sup> A linear, versatile design sporting sophisticated details. Icona conveys its personality by pairing understated beauty with expressiveness. The handle - recessed either horizontally or vertically into the wood panel - is a distinctive, refined accent that can be customised to suit individual tastes: choose from bright or more neutral lacquer colours, with classic metallic or more eccentric finishes. Lacquered, in wood or with a textured finish, the doors come in the hinged, sliding and flush sliding versions.

*In questo ambiente:* **Icona** armadio scorrevole Canaletto e maniglia orizzontale Rame. **Calatea** poltrona in pelle Softy 62 con gambe laccato opaco Lavagna.

<sup>EN</sup> *In this setting:* **Icona** sliding door wardrobe in Canaletto and horizontal handle in Rame. **Calatea** armchair in Softy 62 leather with legs in Lavagna matt lacquer.





Armadio scorrevole con interno materico Canaletto e ripiani in pelle sintetica Creta con bordo materico Canaletto, luce led verticale.

EN Sliding door wardrobe with interior in Canaletto materico and shelves in Creta synthetic leather with edging in Canaletto materico, vertical LED light.

*In questo ambiente:* **Icona** armadio battente con modulo angolo opposto laccato opaco Nuvola, maniglia verticale laccato opaco Nuvola. **Calatea** poltrona in pelle Softy 62, **Duetto** tavolino Bronzo.

*EN In this setting:* **Icona** hinged door wardrobe with opposite corner module in Nuvola matt lacquer, vertical handle in Nuvola matt lacquer. **Calatea** armchair in Softy 62 leather, **Duetto** side table in Bronzo.



*In questo ambiente:* **Icona** armadio complanare laccato lucido Piombo con maniglia orizzontale Titanio, interno laccato opaco Piombo, schienali materico Gioia di Carrara opaco. **Servogiro** tavolino Rovere Cenere con struttura laccato Piombo, **Delano** pouf in tessuto Taigal 51, **Filo Capitonné** letto in pelle Polo 18 con piede laccato opaco Piombo.

<sup>EN</sup> *In this setting:* **Icona** flush-sliding door wardrobe in Piombo high gloss lacquer with horizontal handle in Titanio, interior in Piombo matt lacquer, back panels in matt Gioia di Carrara materico. **Servogiro** side table in Rovere Cenere with structure in Piombo matt lacquer, **Delano** ottoman in Taigal 51 fabric, **Filo Capitonné** bed in Polo 18 leather with feet in Piombo matt lacquer.





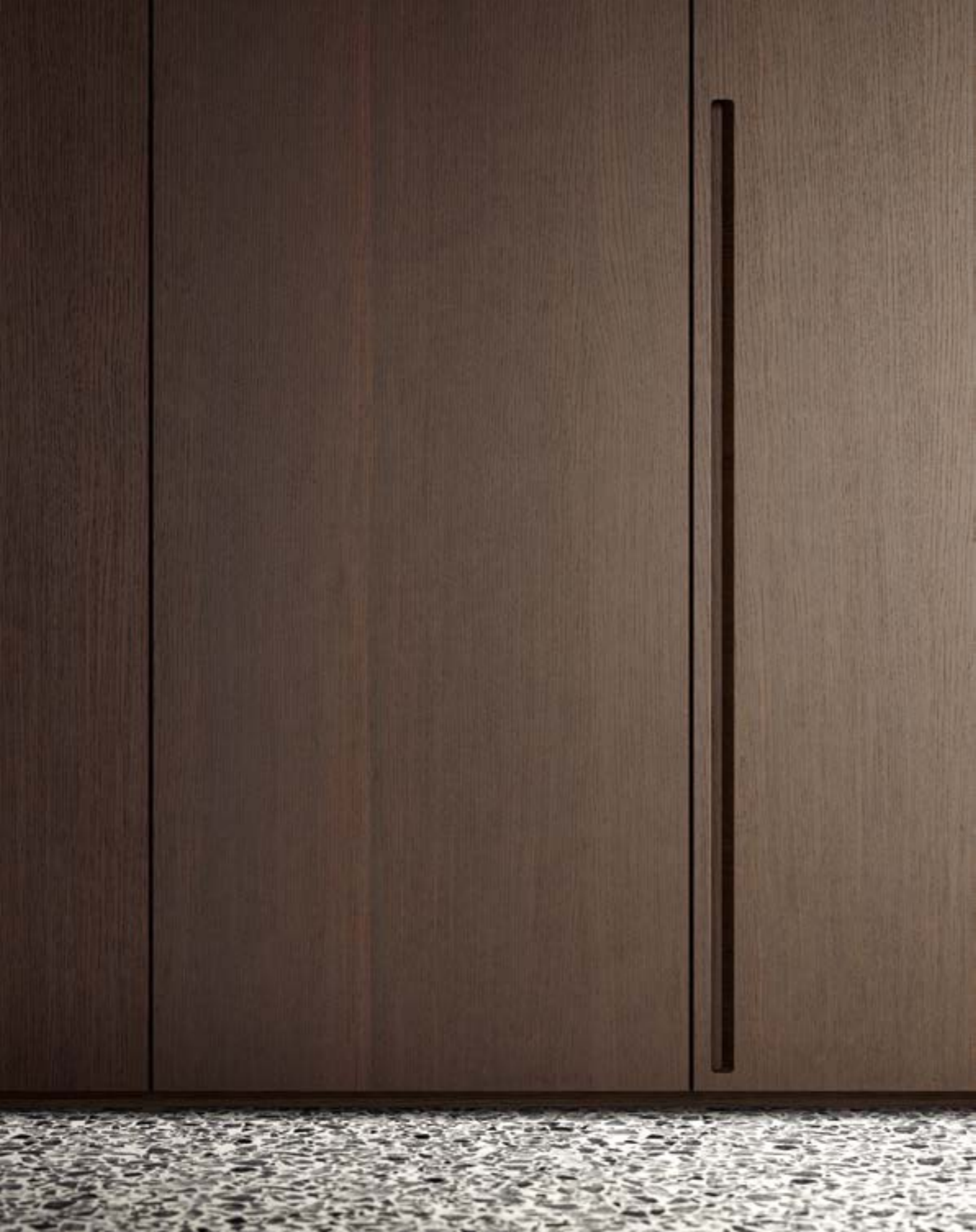

PIANCA

Sistemi Notte  
EN Night Systems

Designer  
Pianca Studio

# Tratto

**Tratto**  
Technical Information  
on p. 236

Una convivenza imbattibile quella tra minimalismo estetico e funzionalità. È una semplicità che conquista per la sua coerenza e la forza della sua essenzialità. Tratto integra e fonde gli elementi dell'anta, ricavando la maniglia all'interno del pannello di legno. Scavata in senso verticale e prossima al bordo dell'anta, garantisce una presa sicura sia nella versione con apertura a battente che scorrevole. Uniformità materica, anche nelle finiture, a scelta tra i laccati e le essenze della collezione.

EN Aesthetic minimalism and functionality are an unbeatable combo. This wardrobe's success lies in its consistent simplicity and in the power of its minimal lines. Tratto integrates and blends the door parts while carving the handle out of the panel. Vertically recessed near the edge of the door, it offers a sound grip on both hinged and sliding doors. Surfaces feature uniform materials available in all the lacquers and wood types of the collection.

*In questo ambiente:* **Tratto** armadio battente e cabina angolare con ante a soffietto Borgogna. **Dedalo** comodino Borgogna, **Fushimi** letto Borgogna e pelle Nabuk 41. Tappeto Ulisse Madera.

EN *In this setting:* **Tratto** hinged door wardrobe and corner walk-in closet with Borgogna folding doors. **Dedalo** night table Borgogna, **Fushimi** bed in Borgogna and Nabuk 41 leather. Carpet Ulisse Madera.

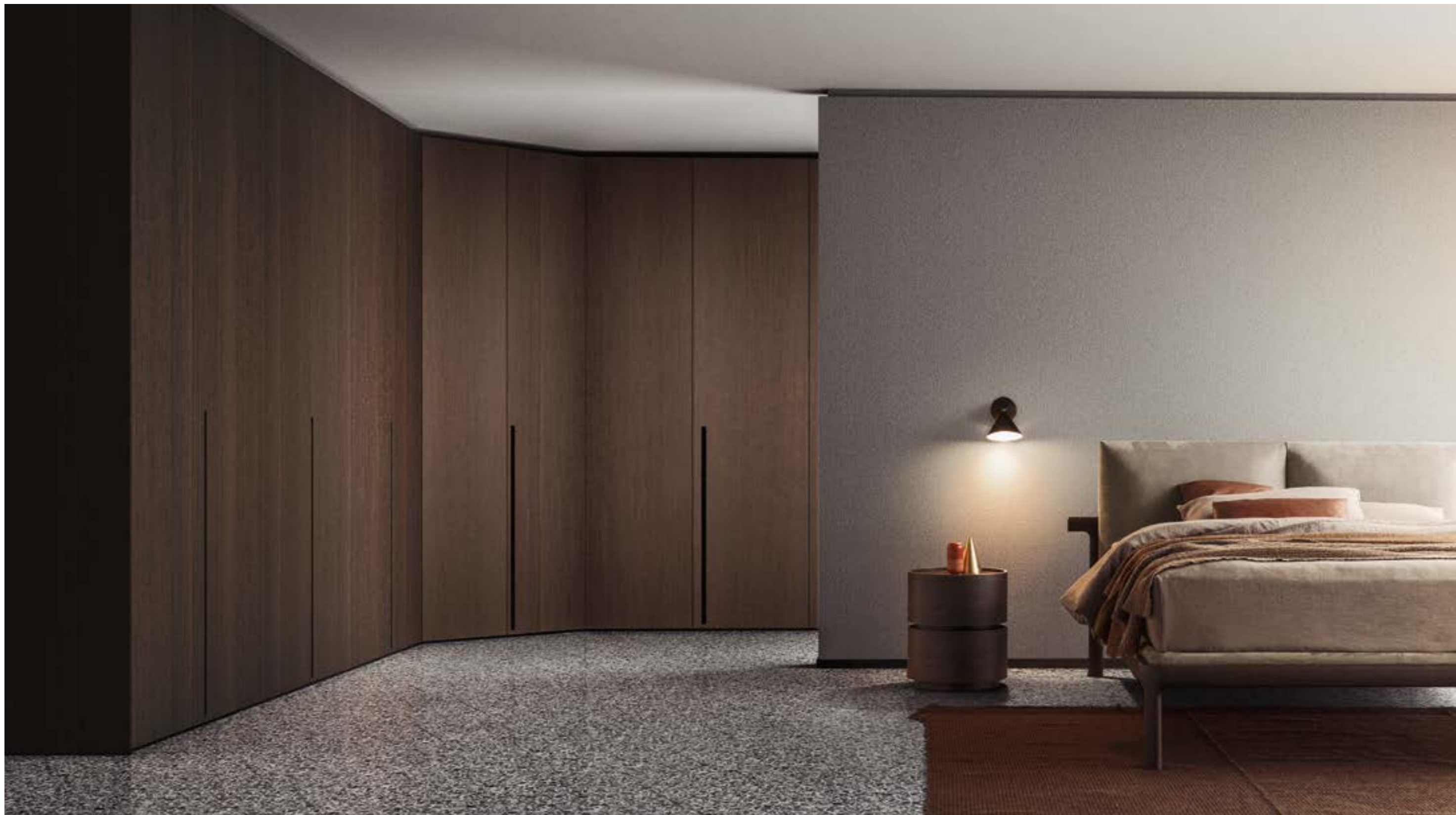



Cabina angolare con ante a soffietto, ripiani materico Borgogna, schienale materico Emperador, cassetiera con frontali oblò vetro Fumé, luce led orizzontale.

<sup>EN</sup> Corner walk-in closet with folding doors, shelves in Borgogna materico, back panel in Emperador materico, drawer unit with fronts in Fumé glass, horizontal LED light.

*In questo ambiente:* **Tratto** armadio scorrevole laccato lucido Seta, interno materico Perlage Terra. **Calatea** poltrone in tessuto Moritz 11 con seduta in Velvet 31 e con stampa esclusiva. Tappeto Apollo Sale e Pepe.

<sup>EN</sup> *In this setting:* **Tratto** sliding door wardrobe in Seta high gloss lacquer, interior in Perlage Terra materico. **Calatea** armchairs in Moritz 11 fabric with seat cushion in Velvet 31 fabric and with Calatea exclusive design. Carpet Apollo Sale e Pepe.







PIANCA

Sistemi Notte  
EN Night Systems

Designer  
Pianca Studio

# Manhattan

**Manhattan**  
Technical Information  
on p. 228

Design fresco e moderno, ispirato ad un'estetica minimale dalle linee contemporanee. Ricorda un affusolato profilo alare la sofisticata geometria della maniglia, costituita da un taglio verticale lungo l'anta e da una parte interna personalizzabile nelle finiture laccate, metallizzate e nelle essenze. Ancora più vasta la possibilità di scelta per le ante, disponibili in vetro, specchio, essenza e laccate, da coordinare o meno con la maniglia, per un effetto tono su tono oppure in contrasto.

EN A fresh, modern design inspired by the contemporary lines of minimal aesthetics. The sophisticated shape of the handle - consisting of a vertical groove in the door edge and of an inner surface that can be customised in lacquered, metallic and wood finishes - is reminiscent of the tapered profile of a wing. The doors come in an even wider range of finishes, available in glass, mirror, wood and lacquer, coordinated with or differing from the handle for a tone-on-tone or contrasting effect.

*In questo ambiente:* **Manhattan** armadio battente laccato opaco Seta con modulo terminale a giorno e interno laccato opaco Seta, maniglia Rame.

EN *In this setting:* **Manhattan** hinged door wardrobe in Seta matt lacquer with open terminal module, interior in Seta matt lacquer, Rame handle.





Modulo terminale a giorno con ripiani laccato opaco Seta.  
**Dioniso** letto Rovere Naturale e tessuto Gaucho 41.  
Portapantaloni e vassoio estraibili con telaio Manganese e frontale materico Seta.

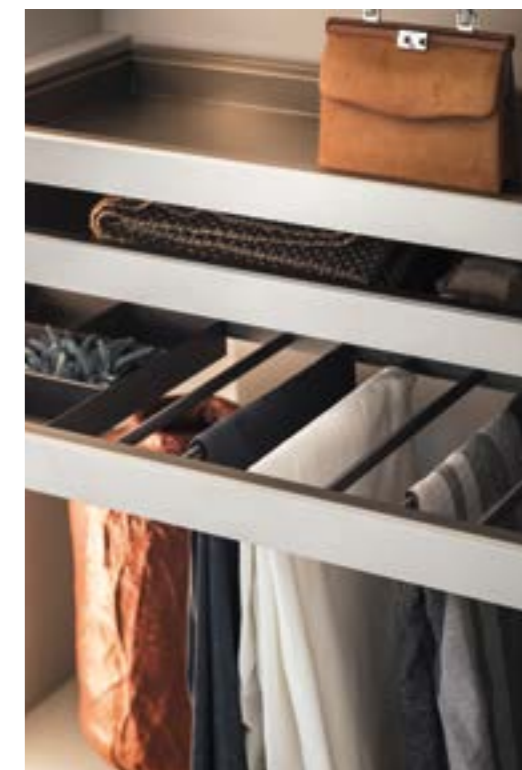

<sup>EN</sup> Open terminal module with shelves in Seta matt lacquer.  
**Dioniso** bed in Rovere Naturale and Gaucho 41 fabric.  
Extractible trousers hanger and tray with Manganese frame and front in Seta materico.

*In questo ambiente:* **Manhattan** armadio scorrevole laccato lucido Cappuccino e maniglia Titanio.

*EN In this setting:* **Manhattan** sliding door wardrobe in Cappuccino high gloss lacquer and Titanio handle.





**Ante decorate**  
**EN Decorated doors**



PIANCA

Sistemi Notte  
EN Night Systems

Designer  
Pianca Studio

# Raggio

**Raggio**  
Technical Information  
on p. 234

Lussuosa, eccentrica ed elegante, la decorazione diventa protagonista. A catturare lo sguardo sono le incisioni verticali che percorrono la superficie dell'anta, alternandosi come raggi discontinui e disegnando dinamici motivi paralleli. Lucide o opache, impreziosiscono i vetri o gli specchi delle ante. Le maniglie sono ricavate a tutta altezza all'interno dell'anta e sono realizzate in alluminio laccato o con finitura metallizzata.

<sup>EN</sup> Lush, eccentric and elegant, embellishments steal the show. Vertical incisions run across the surface of the door, alternating like discontinuous rays of light that sketch dynamic, parallel lines. Gloss or matt, they beautify the glass or mirrored door surfaces. The handles run along the whole height of the inner door edge and come in a lacquered aluminium or metallic finish.

*In questo ambiente:* **Raggio** armadio battente a specchio Inciso Piombo e maniglia Bronzo, modulo TV con cassetti Borgogna. **Servogiro** tavolino laccato opaco Piombo con struttura laccato opaco Lavagna.

<sup>EN</sup> *In this setting:* **Raggio** hinged door wardrobe in Piombo Inciso mirror and Bronzo handle, TV module with drawers in Borgogna. **Servogiro** side table in Piombo matt lacquer with structure in Lavagna matt lacquer.



*In questo ambiente:* **Raggio** armadio complanare a specchio Inciso Fumé e maniglia laccato opaco Lavagna, interno materico Borgogna. **Servogiro** tavolino Borgogna con struttura Bronzo, **Delano** pouf in tessuto Taigal 51.

<sup>EN</sup> *In this setting:* **Raggio** flush-sliding door wardrobe in Inciso Fumé glass and handle in Lavagna matt lacquer, interior in Borgogna materico. **Servogiro** side table in Borgogna with Bronzo structure, **Delano** ottoman in Taigal 51 fabric.





*In questo ambiente:* **Raggio** armadio scorrevole vetro laccato opaco Bianco con incisione in contrasto. **Isotta** poltrona laccato opaco e cuoio Bianco.

*EN In this setting:* **Raggio** sliding door wardrobe in Bianco matt lacquered glass with contrasting carving. **Isotta** armchair in Bianco matt lacquer and leather.





**Raggio** armadio vetro laccato opaco Bianco con maniglia laccato opaco Bianco. Dettaglio vetro laccato opaco con incisione lucida.

<sup>EN</sup> **Raggio** wardrobe with Bianco matt lacquered glass and handle. Detail of matt lacquered glass and high gloss carving.



PIANCA

Sistemi Notte  
EN Night Systems

Designer  
Pianca Studio

# Vela

**Vela**  
Technical Information  
on p. 238

Armonia ed eleganza, scandite da contrasti materici. L'estetica di Vela inverte il classico sviluppo in altezza e propone nuovi equilibri visivi. Tre le fasce orizzontali che vengono a delinearsi grazie ai pannelli centrali che interrompono la continuità delle ante, scorrevoli o complanari. Il contrasto tra le fasce è determinato dalla scelta delle finiture, disponibili tra i laccati e le essenze. La maniglia verticale, ricavata in corrispondenza del pannello centrale, è realizzabile laccata o essenza.

<sup>EN</sup> Harmony and elegance are punctuated by contrasting materials. Vela's design inverts the typical vertical development of the door and suggests new visual effects. The central panels that interrupt the finish of sliding or flush sliding doors create three, horizontal bands. A contrast is achieved by choosing different lacquered or wood finishes for these bands. The vertical handle, carved out of the central panel, is available lacquered or in wood.

*In questo ambiente:* **Vela** armadio complanare laccato opaco Nuvola con fascia centrale Rovere Naturale. **Calatea** poltrona in tessuto Velvet 11 con piede Rovere Naturale. Tappeto Ulisse Sabbia.

<sup>EN</sup> *In this setting:* **Vela** flush-sliding door wardrobe in Nuvola matt lacquer with central panel in Rovere Naturale. **Calatea** armchair in Velvet 11 fabric and feet in Rovere Naturale. Carpet Ulisse Sabbia.



*In questo ambiente:* **Vela** armadio scorrevole laccato lucido Lavagna, fascia centrale laccato opaco Lavagna, interno materico Perlage Conchiglia. **Esse Lounge** poltrona in pelle Nabuk 44 con gambe Rovere Grigio, **Dedalo** comò Rovere Grigio.

<sup>EN</sup> *In this setting:* **Vela** sliding door wardrobe in Lavagna high gloss lacquer, central panel in Lavagna matt lacquer, interior in Perlage Conchiglia materico. **Esse Lounge** armchair in Nabuk 44 leather with legs in Rovere Grigio, **Dedalo** dresser in Rovere Grigio.







Interno armadio con ripiani e cassettera materico Perlage Conchiglia, aste appendiabiti Manganese e luce led orizzontale.

<sup>EN</sup> Wardrobe interior with shelves and drawer unit in Perlage Conchiglia materico, Manganese hangers and horizontal LED light.



PIANCA

Sistemi Notte  
EN Night Systems

Designer  
Pianca Studio

# Crea

**Crea**  
Technical Information  
on p. 224

Design ricercato dallo stile raffinato ed eccentrico. Il motivo geometrico delle ante crea un ritmo di superfici vetrate lucide ed opache: rettangoli di varie dimensioni e proporzioni che si alternano e si accostano trovando radici in un linguaggio artistico moderno. Di grande impatto grafico è la maniglia, che si configura come un taglio orizzontale che rafforza la bellezza della composizione. Può essere laccata opaca o in essenza ed è ricavata all'interno delle ante, disponibili scorrevoli o complanari.

<sup>EN</sup> A refined design with a stylish, eccentric appeal. The geometric door decor offers a juxtaposition of gloss and matt glass surfaces. Various-sized rectangles in different proportions stem from a modern artistic language. The handle has a strong graphic impact, cutting across the doors in a horizontal line that enhances the beauty of the composition. Available matt lacquered or in wood, it is recessed inside the panel of sliding or flush sliding doors.

*In questo ambiente:* **Crea** armadio complanare in vetro opaco e lucido Lavagna. **Atlante** comò con top e profili laccato opaco Lavagna, struttura e frontali laccato lucido Lavagna. Tappeto Teseo Talpa.

<sup>EN</sup> *In this setting:* **Crea** flush-sliding door wardrobe in Lavagna matt and glossy lacquered glass. **Atlante** dresser with top and side trims in Lavagna matt lacquer, structure and fronts in Lavagna high gloss lacquer. Carpet Teseo Talpa.



*In questo ambiente:* **Crea** armadio scorrevole con ante vetro laccato opaco e lucido Argilla, interno materico Perlage Terra, ripiani vetro Fumé, maniglia Borgogna.

<sup>EN</sup> *In this setting:* **Crea** sliding door wardrobe with doors in Argilla matt and glossy lacquered glass, interior in Perlage Terra materico, shelves in Fumé glass, Borgogna handle.





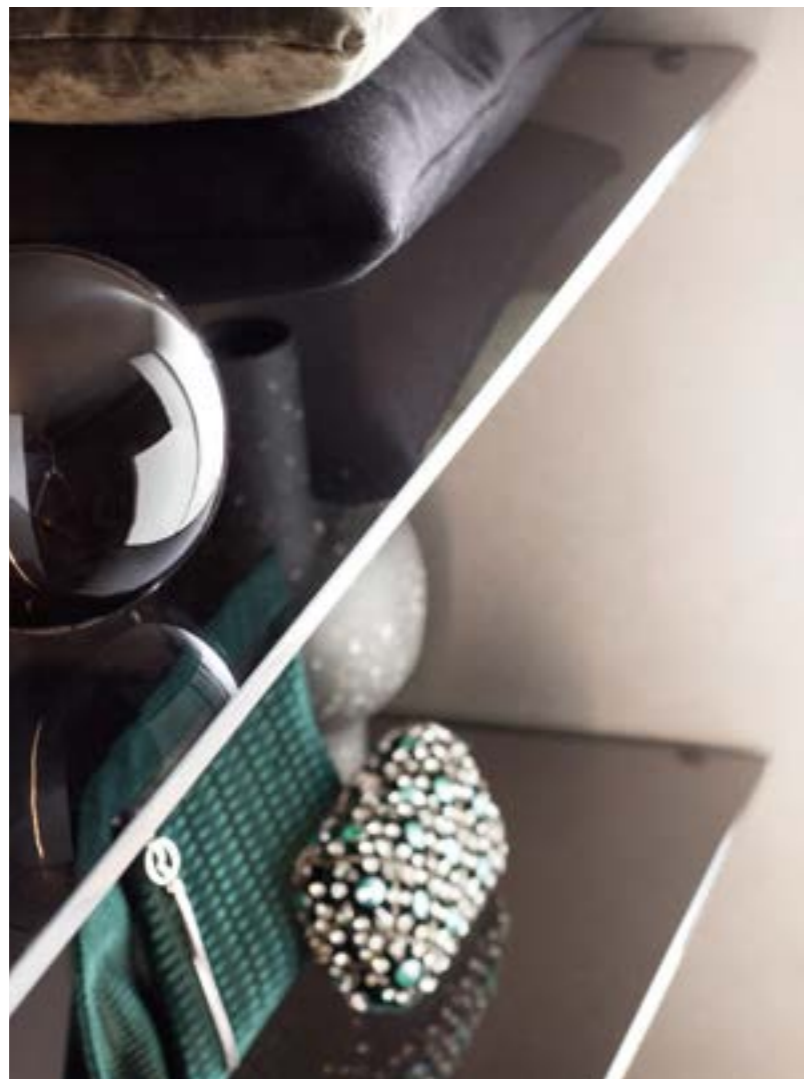

Ripiani vetro Fumè, interno Perlage Terra. Cassettiera materico Perlage Terra con fondo in pelle sintetica Creta, giocassetto materico Argento.

<sup>EN</sup> Shelves in Fumé glass, interior in Perlage Terra. Drawer unit in Perlage Terra materico with bottom of drawers in Creta synthetic leather, Argento materico drawer structure.

**Cabine armadio**  
**EN Walk-in closet**



PIANCA

Sistemi Notte  
EN Night Systems

Designer  
Pianca Studio

# Anteprima

**Anteprima**  
Technical Information  
on p. 304

Scegliere quali capi di abbigliamento indossare, che scarpe ed accessori abbinare è un rito che compiamo nella quotidianità e nelle occasioni speciali. Anteprima nasce per accompagnare ed ispirare i nostri gesti. Soluzioni pratiche ed affascinanti, dotate della massima libertà compositiva ed ampiamente personalizzabili nelle finiture, rispondono alle più esigenti richieste. Disponibile con o senza schienali, la struttura può essere completata con elementi modulari di ogni genere, come ripiani, cassettiere, raster pensili, appenderie.

<sup>EN</sup> Every day of our lives – as well as on special occasions – we repeat the ritual of choosing what clothes to wear and which shoes and accessories to use with them. Anteprima has been designed to accompany and inspire our choices. Practical, fascinating elements allow unsurpassable freedom of arrangement and can be customised in a wide range of finishes to meet the most demanding requests. Available with or without back panels, the structure can be completed by lots of different modular elements such as shelves, drawer units, suspended cubbies and hangers.

*In questo ambiente:* **Anteprima** cabina con schienali materico Borgogna, pelle sintetica Elephant e specchio Piombo; attrezzata con ripiani telaio Manganese e vetro Fumé, portascarpe materico Borgogna, telai estraibili con frontale laccato opaco Argilla. **Island** con ripiani materico Borgogna e teca portaoggetti in vetro trasparente. **Cubo** pouf in tessuto Velvet 41.

<sup>EN</sup> *In this setting:* **Anteprima** walk-in closet with backs in Borgogna materico, Elephant synthetic leather and Piombo mirror; equipped with shelves in Fumé glass and Manganese frame, shoe shelf in Borgogna materico, extractible frames with fronts in Argilla matt lacquer. **Island** with shelves in Borgogna materico and cover in transparent glass. **Cubo** ottoman in Velvet 41 fabric.





Ripiano portascarpe materico Borgogna e battitacco Manganese. Telaio con vassoio Manganese e frontale laccato opaco Argilla.

*Nella pagina seguente:* **Anteprima** e **Sipario** cabina con telaio, **Vista** sistema di chiusura con ante Crystal, **Eden** pouf in tessuto Velvet 41, **Abaco** tavolino in Titanio.



<sup>EN</sup> Shoe shelf in Borgogna materico and Manganese central insert. Frame with Manganese tray and front in Argilla matt lacquer.

*On the following page:* **Anteprima** and **Sipario** walk-in closet with frame, **Vista** door system with Crystal doors, **Eden** ottoman in Velvet 41 fabric, **Abaco** side table in Titanio.





**Island** modulo singolo con ripiani materico Borgogna, vassoi con griglia in pelle sintetica Elephant e teca in vetro trasparente.

<sup>EN</sup> **Island** single module with shelves in Borgogna materico, trays with grid in Elephant synthetic leather and top in transparent glass.

*In questo ambiente: Anteprima* cabina senza schienali con montanti Manganese, attrezzata con ripiani, cassettoni e pedane laccato opaco Seta. **Vista** sistema di chiusura ad angolo con binario a soffitto con pannelli fissi e ante scorrevoli Plana lucido Seta, maniglia Rame.

<sup>EN</sup> *In this setting: Anteprima* walk-in closet without back panels and Manganese vertical supports, equipped with shelves, drawer unit and platforms in Seta matt lacquer. **Vista** door corner system with ceiling mounted rail, with fixed panels and sliding Plana doors in Seta high gloss lacquer, Rame handle.





*In questo ambiente:* **Vista** sistema di chiusura con binario incassato, pannelli fissi e anta Crystal in vetro serigrafato Trama Argento. **Anteprima** cabina con schienali. **Delano** pouf in tessuto Sweet 44, **Geometrika** specchio rettangolare.

<sup>EN</sup> *In this setting:* **Vista** door system with recessed rail, fixed panels and Crystal door in Trama Argento glass. **Anteprima** walk-in closet with backs. **Delano** ottoman in Sweet 44 fabric, **Geometrika** rectangular mirror.





**Anteprima** cabina materico Canaletto con schienale specchio Piombo, aste appendiabiti Manganese, portascarpe, telai estraibili, cassettiere, raster e pedane.

**Anteprima** walk-in closet in Canaletto materico with back panels in Piombo mirror, Manganese hangers, shoe shelves, extractible trays, drawer units, cubbies and platforms.

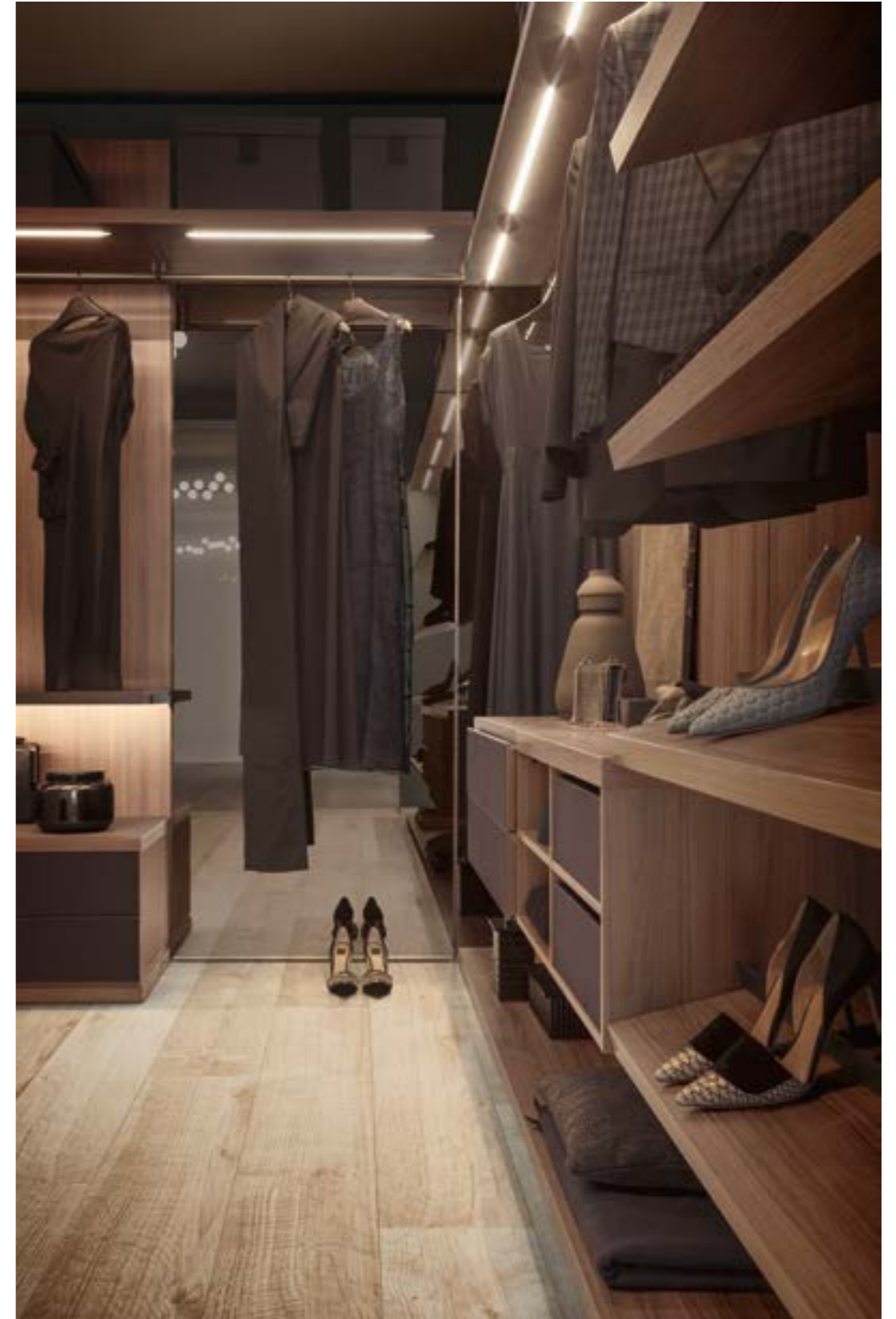





Schienale in materico Grafite opaco e Canaletto, pedana in materico Canaletto, cassettera con frontali in pelle sintetica Talpa.

<sup>EN</sup> Back panel in Grafite matt and Canaletto materico, platform in Canaletto materico, drawer unit with fronts in Talpa synthetic leather.





Raster materico Canaletto con contenitore in pelle sintetica Elephant. Cassetto con frontale, top e accessori in pelle sintetica Elephant.

<sup>EN</sup> Cubbies in Canaletto materico with storage in Elephant synthetic leather. Drawer with front, top and accessories in Elephant synthetic leather.



PIANCA

Sistemi Notte  
EN Night Systems

Designer  
Pianca Studio

# Sipario

**Sipario**  
Technical Information  
on p. 300

Scompaiono i filtri e in scena si combinano eleganza, ordine e raffinatezza. Sipario si compone di moduli armadio senza ante, da accostare in modo libero secondo le proprie esigenze pratiche ed il proprio gusto estetico. Vasta la scelta delle finiture, esaltate, nella versione con telaio, dalla presenza di un'ampia cornice perimetrale che dona alle composizioni un'atmosfera ancora più calda e sofisticata. La gamma di accessori interni è la stessa disponibile per gli armadi ed è in grado di soddisfare ogni esigenza.

<sup>EN</sup> Curtains dissolve to reveal elegance, order and refinement on stage. Sipario is made up of wardrobe modules without doors that can be unrestrictedly put together to suit individual practical requirements and aesthetic preferences. In the framed version, the vast array of finishes is enhanced by a wide frame that gives the arrangement an even warmer and more sophisticated appeal. To satisfy any requirement, our range of interior accessories is the same available for our wardrobes.

*In questo ambiente:* **Sipario** cabina con telaio laccato opaco Lavagna ed interno materico Canaletto. **Plana** armadio battente laccato opaco Lavagna, con apertura push pull. **Chloè Vanity** in tessuto Moritz 52 e laccato opaco Lavagna, **Haik** tavolino Argento, **Eden** pouf in tessuto Positano 51, **Abaco** tavolino laccato opaco Melograno.

<sup>EN</sup> *In this setting:* **Sipario** walk-in closet with frame in Lavagna matt lacquer and interior in Canaletto materico. **Plana** hinged door wardrobe in Lavagna matt lacquered, with push pull opening. **Chloè** dressing table in Moritz 52 fabric and Lavagna matt lacquer, **Haik** side table in Argento, **Eden** ottoman in Positano 51 fabric, **Abaco** side table in Melograno matt lacquer.





Raster con scatole in pelle sintetica Elephant, portascarpe laccato opaco Lavagna, frontale cassetto in vetro laccato lucido Lavagna.

<sup>EN</sup> Cubbies with boxes in Elephant synthetic leather, shoe shelf in Lavagna matt lacquer, drawer front in Lavagna glossy lacquered glass.

*In questo ambiente:* **Vista** sistema di chiusura con binario a soffitto e ante Borgogna, maniglia Oro. **Sipario** cabina in materico Borgogna. **Delano** pouf in tessuto Velvet 44, **Servogiro** tavolino con piano laccato lucido Lavagna e struttura Oro.

<sup>EN</sup> *In this setting:* **Vista** door system with ceiling mounted rail, Borgogna doors and Oro handle. **Sipario** walk-in closet in Borgogna materico. **Delano** ottoman in Velvet 44 fabric, **Servogiro** side table with top in Lavagna high gloss lacquer and Oro structure.







Ripiano in vetro Fumé con telaio materico Borgogna. Frontale cassetto con oblò in vetro Fumé, girocassetto materico Argento e fondo cassetto in pelle sintetica Elephant.

<sup>EN</sup> Shelf in Fumé glass with frame in Borgogna materico. Drawer front in Fumé glass, Argento materico drawer structure and drawer bottom in Elephant synthetic leather.



**Sipario** cabina in materico Borgogna e schiena materico Gioia di Carrara opaco, telaio portapantaloni estraibile, ripiani in vetro con telaio Borgogna. **Delano** pouf in tessuto Velvet 44, **Servogiro** tavolino con piano laccato lucido Lavagna e struttura Oro.

<sup>EN</sup> **Sipario** walk-in closet in Borgogna materico and back panel in matt Gioia di Carrara materico, extractible trouser hanger, glass shelves with Borgogna frame. **Delano** ottoman in Velvet 44 fabric, **Servogiro** side table with top in Lavagna high gloss lacquer and Oro structure.

*In questo ambiente:* **Sipario** cabina con telaio laccato opaco Argilla, interno materico Borgogna. Attrezzata con ripiani, portascarpe, cassettiere e portapantaloni con vaschetta.

*EN In this setting:* **Sipario** walk-in closet with Argilla matt lacquered frame, Borgogna materico interior. Equipped with shelves, shoe shelves, drawer units, trouser hangers with tray.





*In questo ambiente:* **Sipario** cabina in materico Perlage Terra, attrezzata con ripiani in vetro, luce led verticale, portascarpe, cassettiere con frontale vetro laccato lucido Seta. **Anteprima** con schienali in pelle sintetica Elephant, ripiani laccato Ninfea e ripiani con luci led. **Island** modulo doppio con cassetti e ripiani laccato opaco Piombo e teca in vetro trasparente.

*EN In this setting:* **Sipario** walk-in closet in Perlage Terra materico, equipped with glass shelves, vertical LED lights, shoe shelves, drawer units with front in Seta glossy lacquered glass. **Anteprima** with back panels in Elephant synthetic leather, shelves lacquered in Ninfea and shelves with LED light. **Island** double module with drawers and shelves in Piombo matt lacquer and transparent glass top.









**Island** laccato opaco Piombo, vassoi con griglia Manganese e accessori interni in pelle sintetica Elephant, teca in vetro trasparente. Cassetto con telaio estraibile Manganese e ripiano in vetro Fumé.

<sup>EN</sup> **Island** in Piombo matt lacquer, trays with grid in Manganese and internal accessories in Elephant synthetic leather, transparent glass top. Drawer with Manganese extractible frame and shelf in Fumé glass.

**Info tecniche**  
**EN Technical info**

# Struttura

## EN Structure

### Componenti

#### EN Components

Massima flessibilità per costruire uno spazio domestico riservato e personale grazie alla varietà di componenti che assicura una massima libertà progettuale, in grado di inserirsi in ogni spazio,

EN Maximum flexibility to build a personal and private space in your home, thanks to the number of modules granting a complete freedom of design, capable of fitting in every space

### Basi e Cappelli

#### EN Bases and Tops

Le basi sono dotate di piedini regolabili, EN The bases are equipped with adjustable feet

### Finiture, EN Finishes

Laccato Opaco, EN Matt Lacquered

Materico: Bianco, Borgogna, Canaletto, Rovere Laguna, Perlage Terra, Perlage Conchiglia

Tutti i componenti laccati e vetro sono personalizzabili con i colori RAL, EN All lacquered and glass componets can be lacquered in the colors of the RAL range

### Fianchi, sp 3 cm

#### EN Sides, 1.18" th

Presentano nella parte interna un'impronta ogni 6.4 cm per il posizionamento dei ripiani spostabili,

EN On the inside there are marks for shelf support every 2.52"

### Finiture esterne, EN External Finishes

Laccato Opaco o Lucido, Alaska laccato, EN Matt or High Gloss Lacquered, Alaska Lacquered

Soft Touch

Essenza, EN Wood: Borgogna, Canaletto, Rovere Fumo, Rovere Grigio, Rovere Laguna Rovere Naturale, Rovere Tabacco

Materico: Bianco, Cenere, Seta, Alaska, Corsica

### Finiture interne, EN Internal Finishes

Materico: Bianco, Borgogna, Canaletto, Rovere Laguna, Perlage Terra, Perlage Conchiglia

Laccato Opaco, EN Matt Lacquered

### Fianchi di finitura

#### EN Finishing Sides

### Finiture esterne, EN External Finishes

Laccato Opaco o Lucido, EN Matt or High Gloss Lacquered

Soft Touch

Essenza, EN Wood: Borgogna, Canaletto, Rovere Fumo, Rovere Grigio, Rovere Laguna Rovere Naturale, Rovere Tabacco

Vetro, EN Glass: Laccato Opaco o Lucido, EN Matt or Glossy Lacquered

Metallizzato Bronzo

Specchio, EN Mirror: Argento, Fumè, Piombo

### Finiture interne, EN Internal Finishes

Materico: Bianco, Borgogna, Canaletto, Rovere Laguna, Perlage Terra, Perlage Conchiglia

Laccato Opaco, EN Matt Lacquered

### Divisori

#### EN Partitions

Per battente e scorrevole sp 2.2 cm, per complanare sp 4.5 cm. Per cabina soffietto sp 2.2 e 5 cm. Presentano nella parte interna un'impronta ogni 6.4 cm per il posizionamento dei ripiani spostabili,

EN For hinged and sliding doors 0.86"th, for flush sliding door 1.77" th Folding door dressing closets 0.86"and 1.97"th on both sides there are marks for shelf support every 2.52"

### Finiture, EN Finishes

Materico: Bianco, Borgogna, Canaletto, Rovere Laguna, Perlage Terra, Perlage Conchiglia

Laccato Opaco, EN Matt Lacquered

### Schienali

#### EN Backs

### Finiture

Materico: Bianco, Borgogna, Canaletto, Rovere Laguna, Perlage Terra, Perlage Conchiglia

Materico Marmo opaco o lucido, EN Marble materico Matt or Glossy: Gioia di Carrara, Emperador, Grafite

Laccato Opaco, EN Matt Lacquered

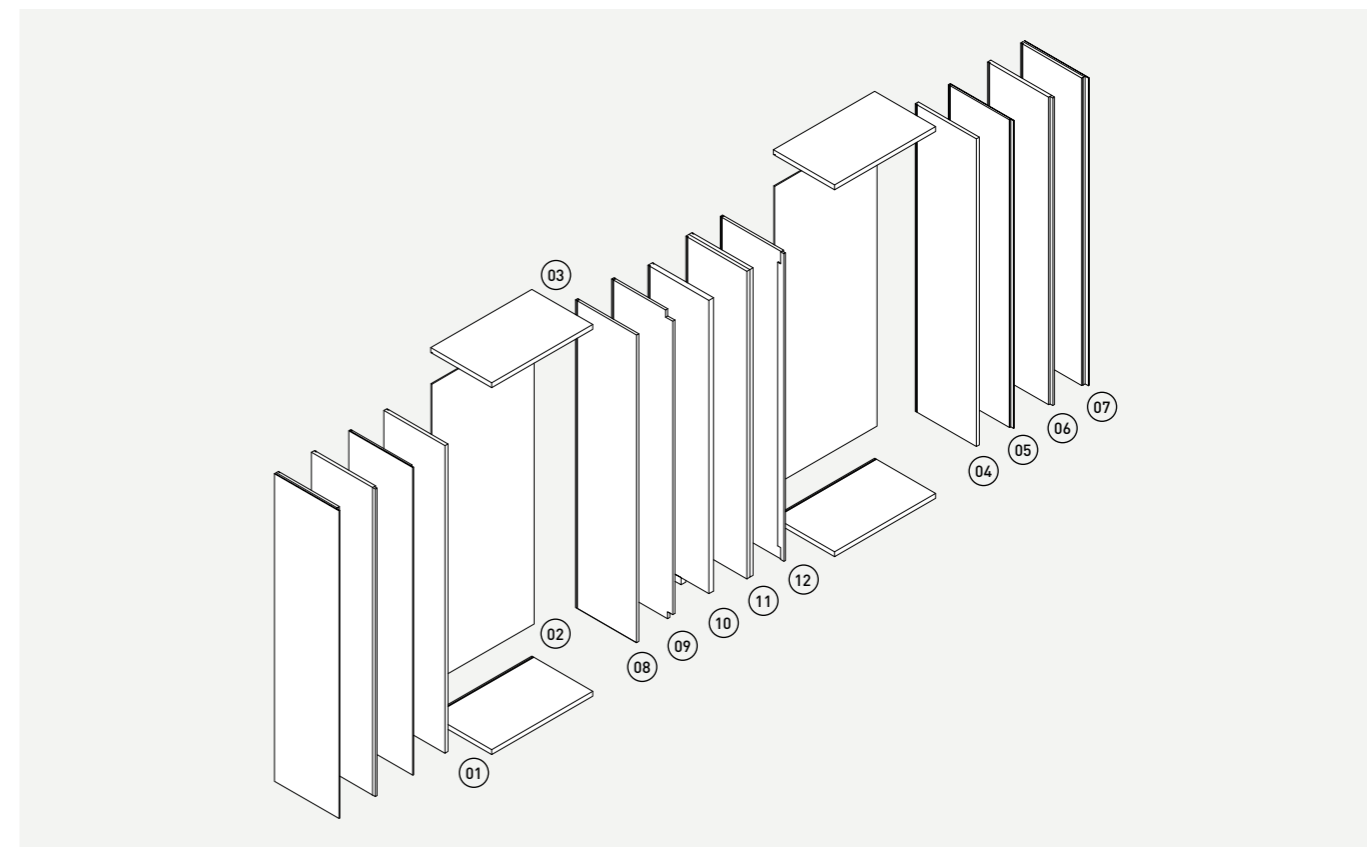

### Nomenclatura

#### EN Nomenclature

**01**  
Base sp 4 cm,  
EN Base 1.57" th

**02**  
Schienale sp 0.8 cm,  
EN Back panel 0.31" th

**03**  
Cappello sp 4 cm,  
EN Top 1.57" th

**04**  
Fianco legno sp 3 cm,  
EN Wooden side 1.18" th

**05**  
Fianco di finitura  
battente sp 1.9 cm,  
EN Finishing side for  
hinged door 0.75" th

**06**  
Fianco legno cornice  
per battente sp 3 cm,  
EN Wooden side frame  
for hinged door 1.18" th

**07**  
Fianco di finitura per  
scorrevole o complanare  
sp 3.9 cm,  
EN Finishing side for sliding  
or flush sliding door 1.54" th

### Divisori interni

#### EN Internal partiotions

**08**  
Battente sp 2.2 cm,  
EN Hinged door 0.87" th

**09**  
Scorrevole sp 2.2 cm,  
EN Sliding door 0.87" th

**10**  
Complanare sp 4.5 cm,  
EN Flush sliding door  
1.77" th

**11**  
Scorrevole 4 ante sp 3+3 cm,  
EN 4 Sliding door wardrobe  
1.30"+ 1.30"th

**12**  
Con cornice per unione  
battente e scorrevole sp  
2.2 cm,  
EN With frame for  
connection with hinged  
and sliding door modules  
0.87" th

# Finiture interne

## <sup>EN</sup> Internal finishes



**Materico Bianco**



**Laccato Opaco nei colori della collezione**  
<sup>EN</sup> Matt Lacquered in all the colors of our collection



**Perlage Conchiglia**



**Perlage Terra**



**Materico Canaletto**



**Materico Borgogna**



**Materico Rovere Laguna**

Tutte le finiture interne sono applicabili a: Base, Cappello, Ripiani, Interno Fianchi, Schienali e Divisori. <sup>EN</sup> All internal finishes are available for: Base, Top, Shelves, Internal Sides, Backs and Partitions.

# Tipologia aperture

## EN Opening types

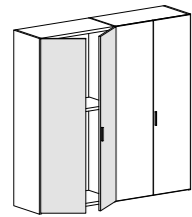

### Battente

#### EN Hinged door

Le ante battenti con maniglia sono dotate di cerniere a molla a chiusura automatica con effetto decelerante. Su richiesta sono disponibili cerniere con apertura a 155°.

EN Hinged doors with handle are equipped with soft-closing hinges. Upon request it is possible to use 155° hinges

#### Modelli, EN Models

Cornice, Manhattan, Milano, Nastro, Raggio, Tratto, Vitrum, Icona, Plana

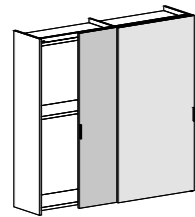

### Scorrevole

#### EN Sliding door

Le ante scorrevoli sono dotate di sistema Soft in apertura e chiusura con effetto decelerante.

EN Sliding doors are equipped with a Soft opening and closing device

#### Modelli, EN Models

Cornice, Crea, Manhattan, Nastro, Raggio, Tratto, Vela, Vitrum, Icona, Plana

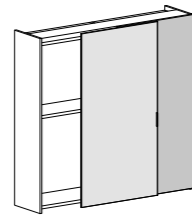

### Complanare

#### EN Flush sliding door

Le ante complanari sono dotate di sistema Soft in apertura e chiusura con effetto decelerante.

EN Flush sliding doors are equipped with a Soft opening and closing device

#### Modelli, EN Models

Plana, Nastro, Raggio, Crea, Vela, Cornice, Icona

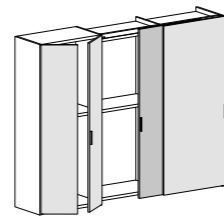

### Aperture Miste

#### EN Mixed openings

Ante scorrevoli e battenti possono essere affiancate tra di loro.

EN Hinged and sliding doors can be used in combination

#### Modelli, EN Models

Cornice, Crea, Manhattan, Milano, Nastro, Raggio, Tratto, Vela, Vitrum, Icona, Plana

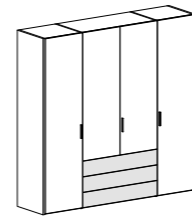

### Cassetti

#### EN Drawers

Cassetti ad estrazione ammortizzata da abbinare ad ante battenti.

EN Drawers with soft closing that can be used with hinged doors

#### Modelli, EN Models

Nastro, Plana

# Modularità

## EN Modularity

### Battente

#### EN Hinged door

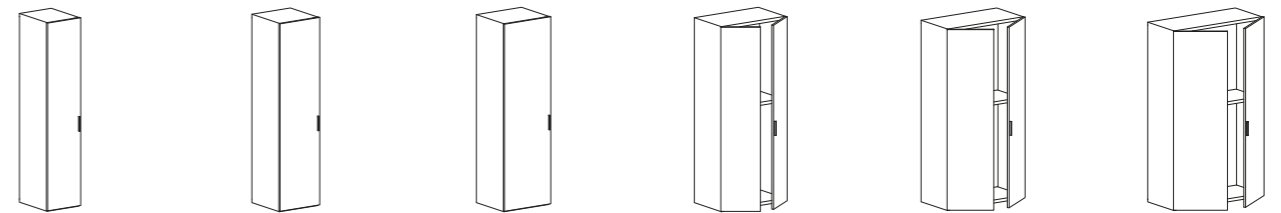

L 47.8 P 42.3 - 59 cm W 18.81" D 16.65" - 23.23"  
 L 57.8 P 42.3 - 59 cm W 22.76" D 16.65" - 23.23"  
 L 67.8 P 42.3 - 59 cm W 26.69" D 16.65" - 23.23"  
 L 97.8 P 42.3 - 59 cm W 38.50" D 16.65" - 23.23"  
 L 117.8 P 42.3 - 59 cm W 46.38" D 16.65" - 23.23"  
 L 137.8 P 42.3 - 59 cm W 54.25" D 16.65" - 23.23"

### Scorrevole

#### EN Sliding door

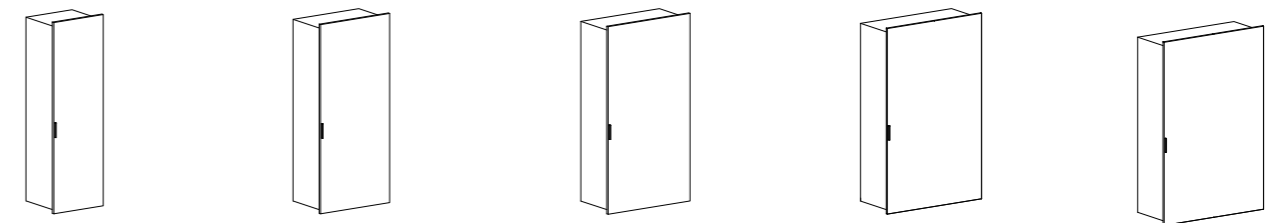

L 67.8 P 42.3 - 59 cm W 26.69" D 16.65" - 23.23"  
 L 97.8 P 42.3 - 59 cm W 38.50" D 16.65" - 23.23"  
 L 117.8 P 42.3 - 59 cm W 46.38" D 16.65" - 23.23"  
 L 137.8 P 42.3 - 59 cm W 54.25" D 16.65" - 23.23"  
 L 147.8 P 42.3 - 59 cm W 58.19" D 16.65" - 23.23"

### Complanare

#### EN Flush Sliding door

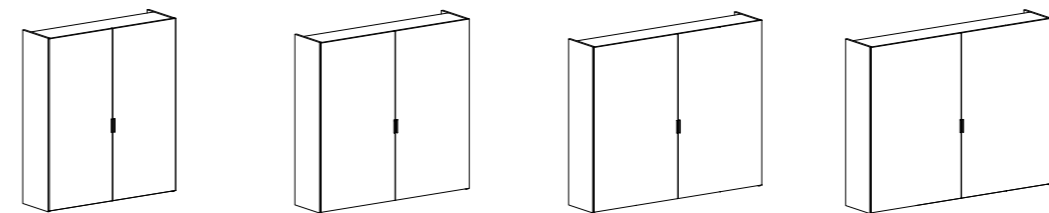

L 206 P 59 cm W 81.10" D 23.23"  
 L 246 P 59 cm W 96.85" D 23.23"  
 L 286 P 59 cm W 112.60" D 23.23"  
 L 306 P 59 cm W 120.47" D 23.23"

# Modularità

## EN Modularity

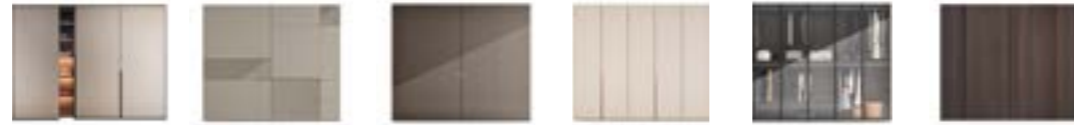

**Cornice**      **Crea**      **Icona**      **Manhattan**      **Milano**      **Nastro**

B   S   C      B   S   C      B   S   C      B   S   C      B   S   C      B   S   C

### Modulo, <sup>EN</sup> Module

L 47.8 cm W 18.81"	•					
L 57.8 cm W 22.76"	•					
L 67.8 cm W 26.69"	•	•				
L 97.8 cm W 38.50"	•	•	•			
L 117.8 cm W 46.38"	•	•	•			
L 137.8 cm W 54.25"	•	•	•			
L 147.8 cm W 58.19"		•	•			
Terminale, <sup>EN</sup> Terminal	•					

### Altezza, <sup>EN</sup> Height

H 238.5 cm W 93.90"	•	•	•			
H 257.7 cm W 101.46"	•	•	•			
H 289.7 cm W 114.06"						
Su Misura, <sup>EN</sup> Custom size	•	•	•			

### Angolo, <sup>EN</sup> Corner

Battente, <sup>EN</sup> Hinged door	•					
Angolo opposto, <sup>EN</sup> External corner						
Scorrevole, <sup>EN</sup> Sliding door						

### Cabina, <sup>EN</sup> Dressing closet

Angolare a soffietto, <sup>EN</sup> Folding door corner	•					
Terminale a soffietto, <sup>EN</sup> Folding door terminal	•					

Legenda  
**B** Battente, <sup>EN</sup> Hinged door  
**S** Scorrevole, <sup>EN</sup> Sliding door  
**C** Complanare, <sup>EN</sup> Flush sliding door



**Plana**      **Raggio**      **Tratto**      **Vela**      **Vitrum**

B   S   C      B   S   C      B   S   C      B   S   C      B   S   C

### Modulo, <sup>EN</sup> Module

L 47.8 cm W 18.81"	•					
L 57.8 cm W 22.76"	•					
L 67.8 cm W 26.69"	•	•				
L 97.8 cm W 38.50"	•	•	•			
L 117.8 cm W 46.38"	•	•	•			
L 137.8 cm W 54.25"	•	•	•			
L 147.8 cm W 58.19"		•	•			
Terminale, <sup>EN</sup> Terminal	•					

### Altezza, <sup>EN</sup> Height

H 238.5 cm W 93.90"	•	•	•			
H 257.7 cm W 101.46"	•	•	•			
H 289.7 cm W 114.06"	•	•				
Su Misura, <sup>EN</sup> Custom size	•	•	•			

### Angolo, <sup>EN</sup> Corner

Battente, <sup>EN</sup> Hinged door	•					
Angolo opposto, <sup>EN</sup> External corner	•					
Scorrevole, <sup>EN</sup> Sliding door						

### Cabina, <sup>EN</sup> Dressing closet

Angolare a soffietto, <sup>EN</sup> Folding door corner	•					
Terminale a soffietto, <sup>EN</sup> Folding door terminal	•					

Legenda  
 \* Non disponibile per la versione vetro,  
<sup>EN</sup> Not available in the glass version

# Moduli speciali

## EN Special modules

- 01**  
Terminale,  
EN Terminal module
- 02**  
Pannelli per modulo  
centrostanza,  
EN Panels for all-side  
finished module
- 03**  
Cabina angolare con  
apertura soffietto,  
EN Corner dressing closet  
with folding doors
- 04**  
Modulo TV,  
EN TV module
- 05**  
Angolo battente opposto,  
EN External corner module
- 06**  
Modulo con vano a giorno,  
EN Module with open  
compartment
- 07**  
Angolo battente,  
EN Hinged door corner  
module
- 08**  
Cassettiera esterna,  
EN External drawer unit
- 09**  
Modulo a ponte con  
scrivania, EN Bridge  
module with desk
- 10**  
Terminale a scrigno,  
EN Module with L-shaped  
opening
- 11**  
Modulo per  
elettrodomestici,  
EN Module for household  
appliances
- 12**  
Modulo stagionale,  
EN Seasonal module
- 13**  
Angolo scorrevole,  
EN Sliding door corner  
module
- 14**  
Modulo sovrapporta,  
EN Over door module
- 15**  
Terminale attrezzato,  
EN Equipped terminal  
module

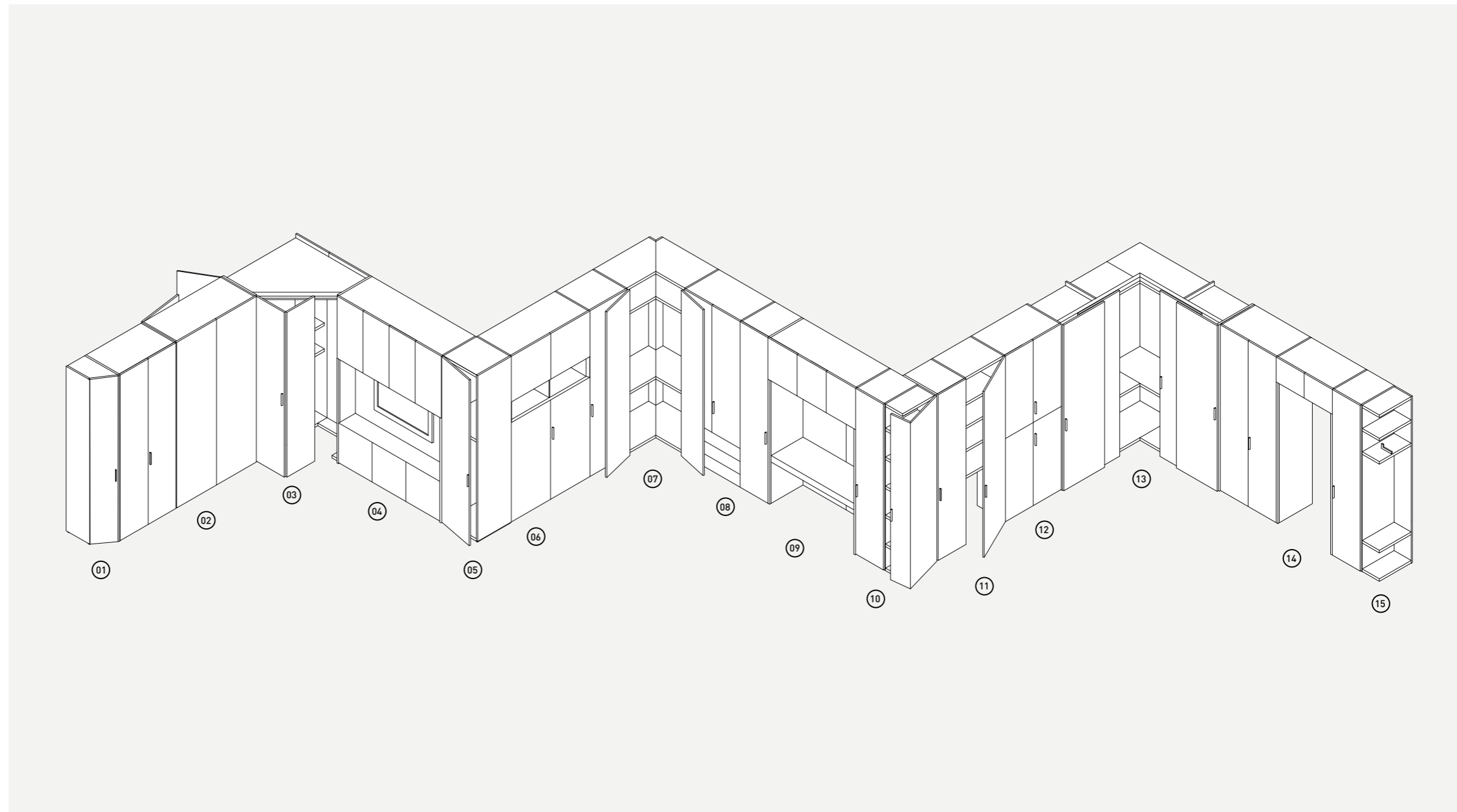

**Collezione ante  
EN Doors collection**

# Cornice

## Aperture EN Openings

Battente, Scorrevole,  
Complanare,  
EN Hinged, Sliding, Flush  
sliding doors

## Finiture EN Finishes

Laccato Opaco o Lucido,  
Alaska Laccato, EN Matt  
or High Gloss Lacquered,  
Alaska Lacquered

+RAL, Soft touch

Essenza, EN Wood:  
Borgogna, Canaletto,  
Rovere Fumo, Rovere  
Grigio, Rovere Laguna  
Rovere Naturale, Rovere  
Tabacco

Materico: Bianco, Cenere,  
Seta, Alaska, Corsica

Vetro, EN Glass:  
Laccato Opaco o Lucido,  
EN Matt or Glossy  
Lacquered

+RAL, Metallizzato  
Bronzo

Specchio, EN Mirror:  
Argento, Fumé, Piombo

Pelle Sintetica,  
EN Synthetic Leather:  
Creta, Elephant, Talpa

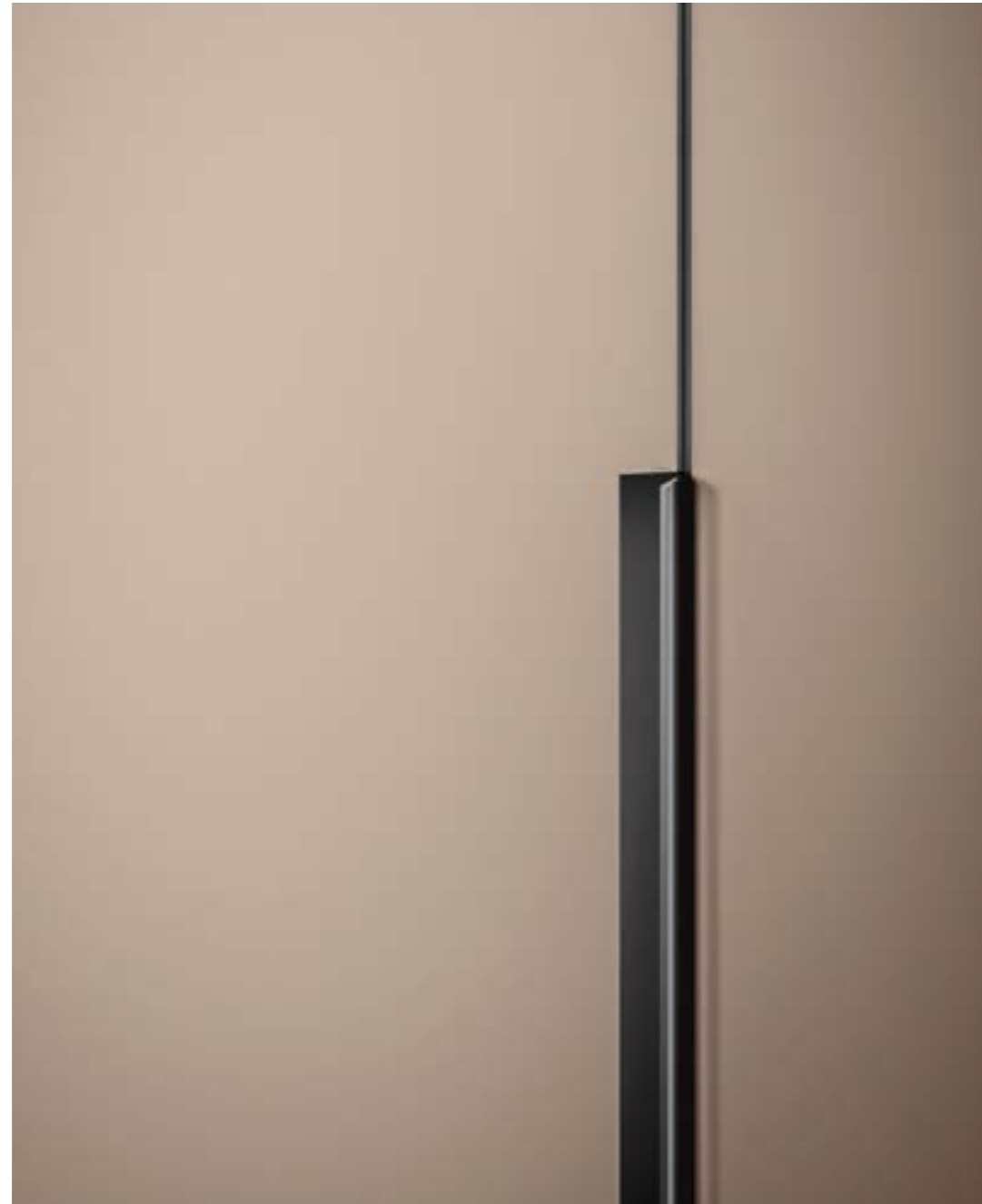

## Maniglia e telaio EN Handle and frame

H 110 cm - 43.31"

Alluminio Anodizzato Nero,  
EN Black Anodized  
Alluminum

Laccato Opaco,  
EN Matt Lacquered

## Battente EN Hinged door

P 42.3 - 59 cm  
H 238.5 - 257.7 cm  
su misura

D 16.65" - 23.23"  
H 93.90" - 101.46"  
custom size

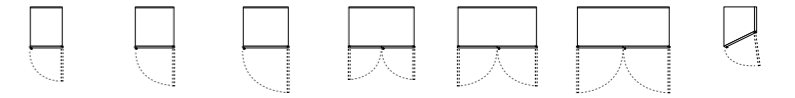

L 47.8 cm W 18.81" L 57.8 cm W 22.76" L 67.8 cm W 26.69" L 97.8 cm W 38.50" L 117.8 cm W 46.38" L 137.8 cm W 54.25" L 46.1 cm\* W 18.15"\*

\*No profondità 42.3 cm, EN Not available depth 16.65"

## Scorrevole EN Sliding door

P 42.3 - 59 cm  
H 238.5 - 257.7 cm  
su misura

D 16.65" - 23.23"  
H 93.90" - 101.46"  
custom size



L 67.8 cm W 26.69" L 97.8 cm W 38.50" L 117.8 cm W 46.38" L 137.8 cm\* W 54.25"\* L 147.8 cm\* W 58.19"\*

\*Larghezza divisa in 2 pannelli, EN Door divided in 2 panels

## Complanare EN Flush Sliding door

P 59 cm  
H 238.5 - 257.7 cm  
su misura

D 23.23"  
H 93.90" - 101.46"  
custom size

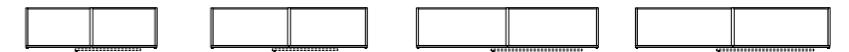

L 206 cm W 81.10" L 246 cm W 96.85" L 286 cm\* W 112.60"\* L 306 cm\* W 120.47"\*

\*Larghezza divisa in 2 pannelli, EN Door divided in 2 panels

## Soluzioni Angolari EN Corner Solutions

Dimensioni pag. 255 - 259  
P 42.3 - 59 cm  
H 238.5 - 257.7 cm  
su misura

EN Dimensions on pag.  
255 - 259  
D 16.65" - 23.23"  
H 93.90" - 101.46"  
custom size

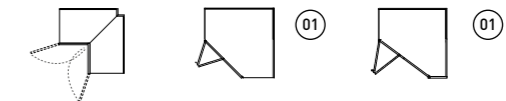

Battente  
EN Hinged  
doors

Cabina  
EN Folding  
door corner

Cabina terminale  
EN Folding door  
terminal

01 \*No profondità 42.3 cm, EN Not available depth 16.65"

## Aperture EN Openings

Scorrevole, Complanare,  
EN Sliding, Flush sliding  
doors

## Finiture EN Finishes

Vetro, EN Glass:  
Laccato Opaco o Lucido,  
EN Matt or Glossy  
Lacquered

+RAL

## Maniglie EN Handles

Laccato Opaco,  
EN Matt Lacquered

Essenza, EN Wood:  
Borgogna, Canaletto,  
Rovere Fumo, Rovere  
Grigio, Rovere Laguna  
Rovere Naturale, Rovere  
Tabacco



## Scorrevole EN Sliding door

P 42.3 - 59 cm  
H 238.5 - 257.7 cm

D 16.65" - 23.23"  
H 93.90" - 101.46"



L 97.8 cm  
W 38.50"



L 117.8 cm  
W 46.38"



L 137.8 cm  
W 54.25"



L 147.8 cm  
W 58.19"

## Complanare EN Flush Sliding door

P 59 cm  
H 238.5 - 257.7 cm

D 23.23"  
H 93.90" - 101.46"

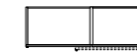

L 206 cm  
W 81.10"



L 246 cm  
W 96.85"



L 286 cm  
W 112.60"



L 306 cm  
W 120.47"

Nella stessa anta non  
si possono abbinare  
differenti colori di vetri.  
Le ante di tipo A e tipo  
B non possono essere  
modificate esteticamente  
nè rese speculari,  
EN It is not possible to  
combine different glass  
colors in the same door.  
Type A and type B doors  
cannot be reversed or  
modified.

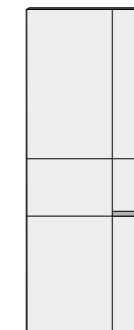

Tipo A

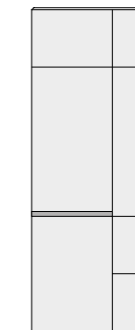

Tipo B

## Aperture EN Openings

Battente, Scorrevole,  
Complanare,  
EN Hinged, Sliding, Flush  
sliding doors

## Finiture EN Finishes

Laccato Opaco o Lucido,  
Alaska Laccato, EN Matt or  
High Gloss Lacquered,  
Alaska Lacquered

+RAL, Soft touch

Essenza, EN Wood:  
Borgogna, Canaletto,  
Rovere Fumo, Rovere  
Grigio, Rovere Laguna  
Rovere Naturale, Rovere  
Tabacco

Materico: Bianco, Genere,  
Seta, Alaska, Corsica

## Maniglia EN Handle

Laccato Opaco, EN Matt  
Lacquered

+RAL

Finiture Metallo,  
EN Metal Finishes:  
Bronzo, Cromo, Oro,  
Rame, Titanio

L 20.2 H 5.2 cm  
Orizzontale;  
L 7 H 40 cm  
Verticale

W 7.95" H 2.05"  
Orizzontale;  
W 2.75" H 15.75"  
Vertical



## Battente EN Hinged door

P 42.3 - 59 cm  
H 238.5 - 257.7 - 289.7 cm  
su misura

D 16.65" - 23.23"  
H 93.90" - 101.46" - 114.06"  
custom size

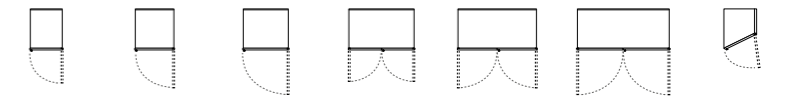

L 47.8 cm W 18.81" L 57.8 cm W 22.76" L 67.8 cm W 26.69" L 97.8 cm W 38.50" L 117.8 cm W 46.38" L 137.8 cm W 54.25" L 46.1 cm\* W 18.15"\*

\*No profondità 42.3 cm, EN Not available depth 16.65"

## Scorrevole EN Sliding door

P 42.3 - 59 cm  
H 238.5 - 257.7 - 289.7 cm  
su misura

D 16.65" - 23.23"  
H 93.90" - 101.46" - 114.06"  
custom size



L 67.8 cm W 26.69" L 97.8 cm W 38.50" L 117.8 cm W 46.38" L 137.8 cm\* W 54.25"\* L 147.8 cm\* W 58.19"\*

\*No altezza 289.7 cm, EN Not available height 114.06"

\*Larghezza divisa in 2 pannelli, EN Door divided in 2 panels

## Complanare EN Flush Sliding door

P 59 cm  
H 238.5 - 257.7 - 289.7 cm  
su misura

D 23.23"  
H 93.90" - 101.46" - 114.06"  
custom size



L 206 cm W 81.10" L 246 cm W 96.85" L 286 cm\* W 112.60"\* L 306 cm\* W 120.47"\*

\*Larghezza divisa in 2 pannelli, EN Door divided in 2 panels

## Soluzioni Angolari EN Corner Solutions

Dimensioni pag. 255 - 259  
H 238.5 - 257.7 - 289.7 cm  
su misura

EN Dimensions on page  
255 - 259  
H 93.90" - 101.46" - 114.06"  
custom size

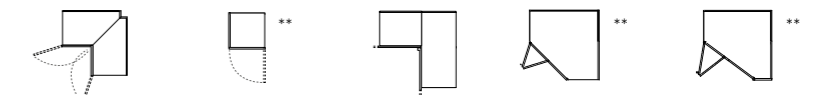

Battente  
EN Hinged  
doors

Opposto  
EN External  
opening

Scorrevole\*  
EN Sliding  
doors\*

Cabina\*  
EN Folding door  
corner\*

Cabina terminale\*  
EN Folding door  
terminal\*

\*No altezza 289.7 cm, EN Not available height 114.06"

\*\*No profondità 42.3 cm, EN Not available depth 16.65"

# Manhattan

## Aperture EN Openings

Battente, Scorrevole,  
EN Hinged, Sliding door

## Finiture EN Finishes

Laccato Opaco o Lucido,  
EN Matt or High Gloss  
Lacquered

+RAL, Soft Touch

Essenza, EN Wood:  
Borgogna, Canaletto,  
Rovere Fumo, Rovere  
Grigio, Rovere Laguna  
Rovere Naturale, Rovere  
Tabacco

Vetro\*, EN Glass\*:  
Laccato Opaco o Lucido,  
EN Matt or Glossy  
Lacquered,

+RAL, Metallizzato  
Bronzo

Specchio\*, EN Mirror\*:  
Argento, Fumé, Piombo

\*Disponibile solo per anta  
battente, EN Available only  
for hinged doors



## Maniglie EN Handles

Laccato Opaco o Lucido,  
EN Matt or High Gloss  
Lacquered

Soft Touch

Essenza, EN Wood:  
Borgogna, Canaletto,  
Rovere Fumo, Rovere  
Grigio, Rovere Laguna  
Rovere Naturale, Rovere  
Tabacco

Finiture Metallo,  
EN Metal Finishes:  
Bronzo, Oro, Rame,  
Titanio, Cromo

## Battente EN Hinged door

P 42.3 - 59 cm  
H 238.5 - 257.7 cm  
su misura

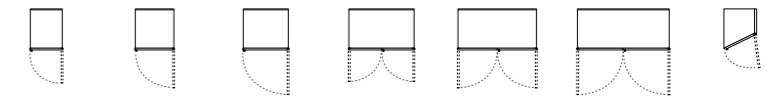

L 47.8 cm W 18.81" L 57.8 cm W 22.76" L 67.8 cm W 26.69" L 97.8 cm W 38.50" L 117.8 cm W 46.38" L 137.8 cm W 54.25" L 46.1 cm\* W 18.15"\*

\*No profondità 42.3 cm, EN Not available depth 16.65"

## Scorrevole EN Sliding door

P 42.3 - 59 cm  
H 238.5 - 257.7 cm  
su misura



L 67.8 cm\* W 26.69"\* L 97.8 cm\* W 38.50"\* L 117.8 cm\* W 46.38"\*

\*Non disponibile per anta vetro, EN Not available for glass door

## Soluzioni Angolari EN Corner Solutions

Dimensioni pag. 255 - 259  
P 42.3 - 59 cm  
H 238.5 - 257.7 cm  
su misura

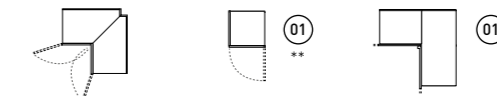

EN Dimensions on page  
255 - 259  
D 16.65" - 23.23"  
custom size

Battente  
EN Hinged  
doors

Opposto  
EN External  
opening

Scorrevole  
EN Sliding  
doors

01 Non disponibile per anta vetro, EN Not available for glass door  
\*\*No profondità 42.3 cm, EN Not available depth 16.65"

# Milano

## Aperture EN Opening

Battente, EN Hinged door

## Finiture EN Finishes

Vetro, EN Glass:  
Extrachiaro Trasparente,  
Fumé Trasparente, Fumé  
Satinato, Metallizzato  
Bronzo, Stop sol, Trama  
Argento, Trama Bronzo,  
Trama Fumé

Specchio, EN Mirror:  
Argento, Fumé, Piombo

## Maniglia e telaio EN Handle and frame

Canna di Fucile, Silicio,  
EN Gunmetal grey,  
Metallized brown



## Battente EN Hinged door

P 42.3 - 59 cm  
H 238.5 - 257.7 - 289.7 cm  
su misura

D 16.65" - 23.23"  
H 93.90" - 101.46" - 114.06"  
custom size



L 47.8 cm  
W 18.81"



L 57.8 cm  
W 22.76"



L 67.8 cm  
W 26.69"



L 97.8 cm  
W 38.50"



L 117.8 cm  
W 46.38"



L 137.8 cm  
W 54.25"

## Soluzioni Angolari EN Corner Solutions

Dimensioni pag. 255 - 259  
P 42.3 - 59 cm  
H 238.5 - 257.7 - 289.7 cm  
su misura

EN Dimensions on page  
255 - 259  
D 16.65" - 23.23"  
H 93.90" - 101.46" - 114.06"  
custom size

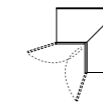

Battente  
EN Hinged  
doors

# Nastro

## Aperture EN Openings

Battente, Scorrevole,  
Complanare  
EN Hinged, Sliding, Flush  
sliding doors

## Finiture EN Finishes

Laccato Opaco o Lucido,  
Alaska Laccato, EN Matt or  
High Gloss Lacquered,  
Alaska Lacquered

+RAL, Soft touch

Essenza, EN Wood:  
Borgogna, Canaletto,  
Rovere Fumo, Rovere  
Grigio, Rovere Laguna  
Rovere Naturale, Rovere  
Tabacco

Materico: Bianco, Cenere,  
Seta, Alaska, Corsica

Vetro, EN Glass:  
Laccato Opaco o Lucido,  
EN Matt or Glossy  
Lacquered

+RAL, Metallizzato Bronzo

Specchio, EN Mirror:  
Argento, Fumé, Piombo

## Maniglia EN Handle

Laccato Opaco,  
EN Matt Lacquered

Finiture Metallo,  
EN Metal Finishes:  
Bronzo, Oro, Rame,  
Titanio, Cromo



## Battente EN Hinged door

No altezza 289.7 cm per anta vetro, EN Not available height 114.06" for glass door

P 42.3 - 59 cm  
H 238.5 - 257.7 - 289.7 cm  
su misura

D 16.65" - 23.23"  
H 93.90" - 101.46" - 114.06"  
custom size

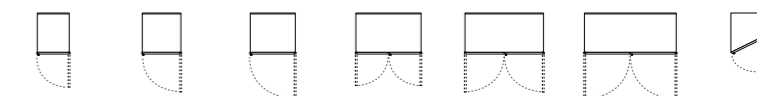

L 47.8 cm W 18.81" L 57.8 cm W 22.76" L 67.8 cm W 26.69" L 97.8 cm W 38.50" L 117.8 cm W 46.38" L 137.8 cm W 54.25" L 46.1 cm\* W 18.15"\*

\*No profondità 42.3 cm, EN Not available depth 16.65"

## Scorrevole EN Sliding door

No altezza 289.7 cm per anta vetro, EN Not available height 114.06" for glass door

P 42.3 - 59 cm  
H 238.5 - 257.7 - 289.7 cm  
su misura

D 16.65" - 23.23"  
H 93.90" - 101.46" - 114.06"  
custom size



L 67.8 cm W 26.69" L 97.8 cm W 38.50" L 117.8 cm W 46.38" L 137.8 cm\* W 54.25"\* L 147.8 cm\* W 58.19"\*

\*No altezza 289.7 cm per anta legno, EN Not available height 114.06" for wooden door  
\*Larghezza divisa in 2 pannelli, EN Door divided in 2 panels

## Complanare EN Flush Sliding door

P 59 cm  
H 238.5 - 257.7 cm  
su misura

D 23.23"  
H 93.90" - 101.46"  
custom size



L 206 cm W 81.10" L 246 cm W 96.85" L 286 cm\* W 112.60"\* L 306 cm\* W 120.47"\*

\*Larghezza divisa in 2 pannelli, EN Door divided in 2 panels

## Soluzioni Angolari EN Corner Solutions

Dimensioni pag. 255 - 259  
P 42.3 - 59 cm  
H 238.5 - 257.7 - 289.7 cm  
su misura

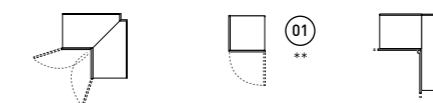

EN Dimensions on page  
255 - 259  
D 16.65" - 23.23"  
H 93.90" - 101.46" - 114.06"  
custom size

Battente\*  
EN Hinged  
doors\*

Opposto  
EN External  
opening

Scorrevole\*  
EN Sliding  
doors\*

\*No altezza 289.7 cm per anta vetro, EN Not available height 114.06" for glass door  
\*\*No profondità 42.3 cm, EN Not available depth 16.65"

01 Non disponibile per anta vetro, EN Not available for glass door

# Raggio

## Aperture EN Openings

Battente, Scorrevole,  
Complanare  
EN Hinged, Sliding, Flush  
sliding doors

## Finiture EN Finishes

Vetro, EN Glass:  
Laccato Opaco o Lucido,  
EN Matt or Glossy  
Lacquered

+RAL

Specchio, EN Mirror:  
Argento, Fumé, Piombo

## Maniglia EN Handle

Laccato Opaco,  
EN Matt Lacquered

Finiture Metallo,  
EN Metal Finishes:  
Bronzo, Oro, Rame,  
Titanio, Cromo



## Battente EN Hinged door

P 42.3 - 59 cm  
H 238.5 - 257.7 cm  
su misura

D 16.65" - 23.23"  
H 93.90" - 101.46"  
custom size

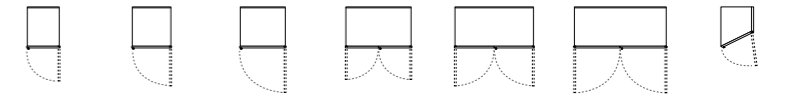

L 47.8 cm W 18.81"   L 57.8 cm W 22.76"   L 67.8 cm W 26.69"   L 97.8 cm W 38.50"   L 117.8 cm W 46.38"   L 137.8 cm W 54.25"   L 46.1 cm\* W 18.15"\*

\*No profondità 42.3 cm, EN Not available depth 16.65"

## Scorrevole EN Sliding door

P 42.3 - 59 cm  
H 238.5 - 257.7 cm  
su misura

D 16.65" - 23.23"  
H 93.90" - 101.46"  
custom size



L 67.8 cm W 26.69"   L 97.8 cm W 38.50"   L 117.8 cm W 46.38"   L 137.8 cm\* W 54.25"\*   L 147.8 cm\* W 58.19"\*

\*Larghezza divisa in 2 pannelli, EN Door divided in 2 panels

## Complanare EN Flush Sliding door

P 59 cm  
H 238.5 - 257.7 cm  
su misura

D 23.23"  
H 93.90" - 101.46"  
custom size



L 206 cm W 81.10"   L 246 cm W 96.85"   L 286 cm\* W 112.60"\*   L 306 cm\* W 120.47"\*

\*Larghezza divisa in 2 pannelli, EN Door divided in 2 panels

## Soluzioni Angolari EN Corner Solutions

Dimensioni pag. 255 - 259  
P 42.3 - 59 cm  
H 238.5 - 257.7 cm  
su misura

EN Dimensions on page  
255 - 259  
D 16.65" - 23.23"  
H 93.90" - 101.46"  
custom size

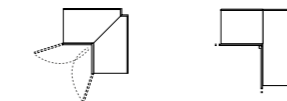

Battente  
EN Hinged  
doors

Scorrevole  
EN Sliding  
doors

# Tratto

## Aperture EN Openings

Battente, Scorrevole,  
EN Hinged, Sliding doors

## Finiture EN Finishes

Laccato Opaco o Lucido,  
EN Matt or High Gloss  
Lacquered

+RAL, Soft Touch

Essenza, EN Wood:  
Borgogna, Canaletto,  
Rovere Fumo, Rovere  
Grigio, Rovere Laguna  
Rovere Naturale, Rovere  
Tabacco

## Maniglia EN Handle

Verticale ricavata  
nell'anta, EN Vertical  
groove



## Battente EN Hinged door

P 42.3 - 59 cm  
H 238.5 - 257.7 cm  
su misura

D 16.65" - 23.23"  
H 93.90" - 101.46"  
custom size

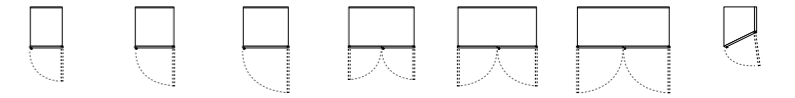

L 47.8 cm   L 57.8 cm   L 67.8 cm   L 97.8 cm   L 117.8 cm   L 137.8 cm   L 46.1 cm\*  
W 18.81"   W 22.76"   W 26.69"   W 38.50"   W 46.38"   W 54.25"   W 18.15"\*

\*No profondità 42.3 cm, EN Not available depth 16.65"

## Scorrevole EN Sliding door

P 42.3 - 59 cm  
H 238.5 - 257.7 cm  
su misura

D 16.65" - 23.23"  
H 93.90" - 101.46"  
custom size



L 97.8 cm   L 117.8 cm  
W 38.50"   W 46.38"

## Soluzioni Angolari EN Corner Solutions

Dimensioni pag. 255 - 259  
P 42.3 - 59 cm  
H 238.5 - 257.7 cm  
su misura

EN Dimensions on page  
255 - 259  
D 16.65" - 23.23"  
H 93.90" - 101.46"  
custom size

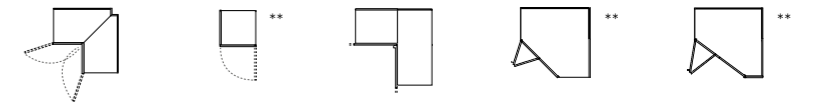

Battente  
EN Hinged  
doors

Opposto  
EN External  
opening

Scorrevole  
EN Sliding  
doors

Cabina  
EN Folding door  
corner

Cabina terminale  
EN Folding door  
terminal

\*\*No profondità 42.3 cm, EN Not available depth 16.65"

# Vela

## Aperture EN Openings

Scorrevole, Complanare  
EN Sliding, Flush sliding  
doors

## Finiture EN Finishes

Pannello inferiore e  
superiore, EN Lower and  
upper door panel

Laccato Opaco o Lucido,  
EN Matt or High Gloss  
Lacquered

+RAL, Soft touch

## Fascia centrale, EN Central panel

Essenza, EN Wood:  
Borgogna, Canaletto,  
Rovere Fumo, Rovere  
Grigio, Rovere Laguna  
Rovere Naturale, Rovere  
Tabacco

Laccato Opaco o Lucido,  
EN Matt or High Gloss  
Lacquered

+RAL

## Maniglia EN Handle

Verticale in tinta con  
pannello centrale dell'  
anta, EN Vertical handle  
inserted in the central  
panel of the door



## Scorrevole EN Sliding doors

P 42.3 - 59 cm  
H 238.5 - 257.7 cm

D 16.65" - 23.23"  
H 93.90" - 101.46"



L 97.8 cm  
W 38.50"



L 117.8 cm  
W 46.38"



L 137.8 cm  
W 54.25"



L 147.8 cm  
W 58.19"

## Complanare EN Flush Sliding door

P 59 cm  
H 238.5 - 257.7 cm

D 23.23"  
H 93.90" - 101.46"

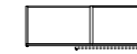

L 206 cm  
W 81.10"

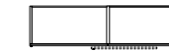

L 246 cm  
W 96.85"



L 286 cm  
W 112.60"

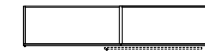

L 306 cm  
W 120.47"

## Aperture EN Openings

Battente, Scorrevole,  
EN Hinged, Sliding doors

## Finiture EN Finishes

Vetro, EN Glass:  
Fumé Trasparente,  
Fumé Satinato, Stop-sol,  
Trama Argento, Trama  
Bronzo, Trama Fumé,  
Trasparente Extrachiaro

## Maniglia e telaio EN Handle and frame

H 110 cm - 43.31"

Alluminio Anodizzato  
Nero, EN Black Anodized  
Alluminum



## Battente EN Hinged door

P 42.3 - 59 cm  
H 238.5 - 257.7 cm

D 16.65" - 23.23"  
H 93.90" - 101.46"

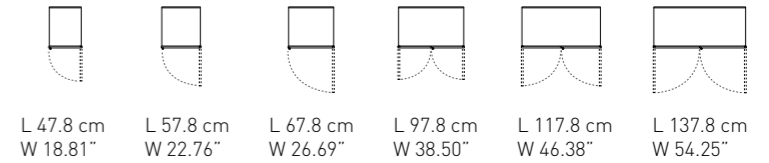

## Scorrevole EN Sliding door

P 42.3 - 59 cm  
H 238.5 - 257.7 cm

D 16.65" - 23.23"  
H 93.90" - 101.46"



# Plana

## Aperture EN Openings

Battente, Scorrevole,  
Complanare,  
EN Hinged, Sliding, Flush  
sliding doors

## Finiture EN Finishes

Laccato Opaco o Lucido,  
Alaska Laccato, EN Matt  
or High Gloss Lacquered,  
Alaska Lacquered

+RAL, Soft touch

Essenza, EN Wood:  
Borgogna, Canaletto,  
Rovere Fumo, Rovere  
Grigio, Rovere Laguna  
Rovere Naturale, Rovere  
Tabacco

Materico: Bianco, Cenere,  
Seta, Alaska, Corsica



## Maniglie EN Handles

	B	S	C
A18	•	•	•
A39	•	•	•
A84	•	•	•
B12	•		
D30	•	•	
H5		•	
L110	•	•	•
V30	•	•	
V72	•	•	
Y30	•	•	
Y110	•	•	
W40	•	•	•
W110	•	•	•
Push pull	•		
Chiave	•		
Ser. El./Mec.	•		

### Legenda

**B** Battente, EN Hinged door  
**S** Scorrevole, EN Sliding door  
**C** Complanare, EN Flush  
sliding door

## Battente EN Hinged door

P 42.3 - 59 cm  
H 238.5 - 257.7 - 289.7 cm  
su misura

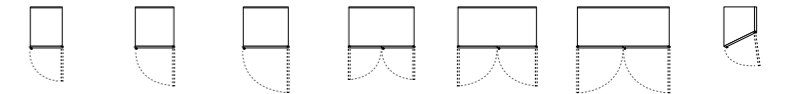

D 16.65" - 23.23"  
H 93.90" - 101.46" - 114.06"  
custom size

L 47.8 cm W 18.81" L 57.8 cm W 22.76" L 67.8 cm W 26.69" L 97.8 cm W 38.50" L 117.8 cm W 46.38" L 137.8 cm W 54.25" L 46.1 cm W 18.15"\*

\*No profondità 42.3 cm, EN Not available depth 16.65"

## Scorrevole EN Sliding door

P 42.3 - 59 cm  
H 238.5 - 257.7 - 289.7 cm  
su misura



D 16.65" - 23.23"  
H 93.90" - 101.46" - 114.06"  
custom size

L 67.8 cm W 26.69" L 97.8 cm W 38.50" L 117.8 cm W 46.38" L 137.8 cm\* W 54.25"\* L 147.8 cm\* W 58.19"\*

\*No altezza 289.7 cm, EN Not available height 114.06"  
\*Larghezza divisa in 2 pannelli, EN Door divided in 2 panels

## Complanare EN Flush Sliding door

P 59 cm  
H 238.5 - 257.7 cm  
su misura

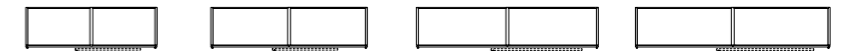

D 23.23"  
H 93.90" - 101.46"  
custom size

L 206 cm W 81.10" L 246 cm W 96.85" L 286 cm\* W 112.60"\* L 306 cm\* W 120.47"\*

\*Larghezza divisa in 2 pannelli, EN Door divided in 2 panels

## Soluzioni Angolari EN Corner Solutions

Dimensioni pag. 255 - 259  
P 42.3 - 59 cm  
H 238.5 - 257.7 - 289.7 cm  
su misura

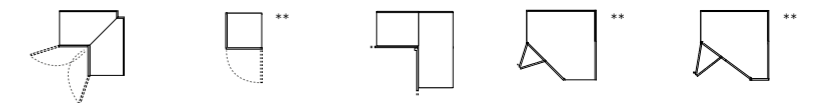

EN Dimensions on page  
255 - 259  
D 16.65" - 23.23"  
H 93.90" - 101.46" - 114.06"  
custom size

Battente  
EN Hinged  
doors  
Opposto  
EN External  
opening  
Scorrevole\*  
EN Sliding  
doors\*  
Cabina\*  
EN Folding door  
corner\*  
Cabina terminale\*  
EN Folding door  
terminal\*

\*No altezza 289.7 cm, EN Not available height 114.06"  
\*\*No profondità 42.3 cm, EN Not available depth 16.65"

# Maniglie

## EN Handles

### Finiture EN Finishes

Essenza, <sup>EN</sup> Wood:  
Borgogna, Canaletto,  
Rovere Fumo, Rovere  
Grigio, Rovere Laguna  
Rovere Naturale, Rovere  
Tabacco

Laccato Opaco,  
<sup>EN</sup> Matt Lacquered

Finiture Metallo,  
<sup>EN</sup> Metal Finishes:  
Bronzo, Cromo, Oro,  
Rame, Titanio

Alluminio Anodizzato  
Nero, <sup>EN</sup> Black Anodized  
Alluminum

Cuoio, <sup>EN</sup> Leather:  
Moro, Nero, Siena



**A 18**

Laccato, <sup>EN</sup> Lacquered  
Finiture Metallo,  
<sup>EN</sup> Metal Finishes  
Essenza, <sup>EN</sup> Wood



**V 30**

Cromo satinato,  
Alluminio



**A 39**

Laccato, <sup>EN</sup> Lacquered  
Finiture Metallo,  
<sup>EN</sup> Metal Finishes  
Essenza, <sup>EN</sup> Wood



**V 72**

Cromo satinato,  
Alluminio



**A 84**

Laccato, <sup>EN</sup> Lacquered  
Finiture Metallo,  
<sup>EN</sup> Metal Finishes  
Essenza, <sup>EN</sup> Wood



**D 30**

Laccato <sup>EN</sup> Lacquered  
Finiture Metallo,  
<sup>EN</sup> Metal Finishes



**L 110**

Laccato, <sup>EN</sup> Lacquered  
Finiture Metallo,  
<sup>EN</sup> Metal Finishes  
Alluminio



**B 12**

Cuoio, <sup>EN</sup> Leather



**W 40**

Laccato, <sup>EN</sup> Lacquered  
Essenza, <sup>EN</sup> Wood



**H 5**

Finiture Metallo,  
<sup>EN</sup> Metal Finishes,  
Cromo, Brunito



**W 110**

Laccato, <sup>EN</sup> Lacquered  
Essenza, <sup>EN</sup> Wood



**Chiave**

Cuoio, <sup>EN</sup> Leather:  
Moro



**Y 30**

Laccato, <sup>EN</sup> Lacquered  
Finiture metallo,  
<sup>EN</sup> Metal Finishes



**Push pull**



**Y 110**

Laccato, <sup>EN</sup> Lacquered  
Finiture metallo,  
<sup>EN</sup> Metal Finishes

**Moduli speciali**  
**<sup>EN</sup> Special modules**

# Modulo stagionale

## EN Seasonal module

### Modularità

#### EN Modularity

P 42.3 - 59 cm  
L 47.8 - 57.8 - 67.8 - 97.8  
117.8 - 137.8 cm  
H 238.5 - 257.7 - 289.7 cm  
su misura

D 16.65" - 23.23"  
W 18.81" - 22.76" - 26.69"  
38.50" - 46.38" - 54.25"  
H 93.90" - 101.46" - 114.06"  
custom size

Altezza minima dell'anta  
64 cm. Previste altezze  
intermedie a passo 6.4 cm,  
EN Minimum door height:  
25.20". Other heights  
available at a 2.52" pitch.

### Modelli

#### EN Models

Plana battente, EN Hinged  
door:

Esclusi moduli angolo e  
terminali,  
EN Except for corner and  
terminal modules

### Finiture Interne

#### EN Internal Finishes

Materico: Bianco,  
Borgogna, Canaletto,  
Rovere Laguna, Perlage  
Conchiglia, PerlageTerra

Laccato Opaco,  
EN Matt Lacquered

### Maniglie

#### EN Handles

A18, A39, D30, W40, V30

Possono essere  
posizionate a 2.6 cm dal  
filo superiore o inferiore  
dell'anta; o mantenere la  
posizione della maniglia  
di serie,

EN Can be positioned  
at 1.02" from the door's  
upper or lower edge;  
or kept in its standard  
position



# Modulo per elettrodomestici

## EN Module for household appliances

### Modularità

#### EN Modularity

P 59 cm  
L 67.8 cm  
H 238.5 - 257.7 - 289.7 cm  
su misura

D 23.23"  
W 26.69"  
H 93.90" - 101.46" - 114.06"  
custom size

Ripiano con profondità  
maggiorata sul retro e  
a filo struttura davanti,  
posizionato sempre da  
terra a 100 cm

Elettrodomestici  
L max 60 cm  
H max 90 cm,

EN Shelf with increased  
depth at the back and  
flush with the front  
structure, always  
positioned at a height  
of 39.37"

Household appliances  
W max 23.62"  
H max 35.43"

### Modelli

#### EN Models

Plana battente, EN Hinged  
door

### Finiture Interne

#### EN Internal Finishes

Materico: Bianco,  
Borgogna, Canaletto,  
Rovere Laguna, Perlage  
Conchiglia, PerlageTerra

Laccato Opaco,  
EN Matt Lacquered

### Maniglie

#### EN Handles

A18, A39, A 84, B12, D30,  
L110, V30, V72, W40, W110,  
Y30, Y110, Push-pull

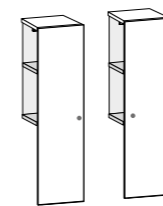

# Modulo cassetiera esterna

## EN External drawer units module

Modularità EN Modularity	Modelli EN Models	Finiture Interne EN Internal Finishes	Maniglie EN Handles
P 42.3 - 59 cm L 47.8 - 57.8 - 67.8 - 97.8 117.8 - 137.8 cm H 238.5 - 257.7 - 289.7 cm su misura	Nastro*, Plana  *Solo per anta legno, EN Only for wooden doors	Materico: Bianco, Borgogna, Canaletto, Rovere Laguna, Perlage Conchiglia, PerlageTerra  Laccato Opaco, EN Matt Lacquered	Plana: A18, B12, D30, Y30, Push pull  Cassetti, EN Drawer units: Y30, Push pull  Nastro: maniglia di serie, EN Standard handle

### 01-02 Plana Anta, EN Door

Cassetto H 19.7 cm,  
EN Drawer H 7.76"

2 Cassetti, EN Drawers  
3 Cassetti, EN Drawers  
4 Cassetti, EN Drawers

Cestone H 29.7 cm,  
EN Tall drawer H 11.69"

1 Cassetto, EN Drawer  
2 Cassetti, EN Drawers

### 03-04 Nastro Anta, EN Door

Cassetto H 19.7 cm,  
EN Drawer H 7.76"

2 Cassetti, EN Drawers  
4 Cassetti, EN Drawers

Cestone H 29.7 cm  
EN Tall drawer H 11.69"

2 Cassetti, EN Drawers



01



02



03



04

# Modulo con vano a giorno

## EN Module with open element

Modularità EN Modularity	Modelli EN Models	Finiture Interne EN Internal Finishes	Finiture modulo giorno, EN Open element finishes	Maniglie EN Handles
P 42.3 - 59 cm L 47.8 - 57.8 - 67.8 - 97.8 117.8 - 137.8 cm H 238.5 - 257.7 - 289.7 cm su misura	Plana	Materico: Bianco, Borgogna, Canaletto, Rovere Laguna, Perlage Conchiglia, PerlageTerra  Laccato Opaco, EN Matt Lacquered	Laccato Opaco, EN Matt Lacquered, +RAL.  Essenza, EN Wood: Borgogna, Canaletto, Rovere Fumo, Rovere Grigio, Rovere Laguna Rovere Naturale, Rovere Tabacco	Moduli superiori push pull. Modulo inferiore tutte le maniglie anta Plana, EN Push pull for upper modules. All Plana handles for lower modules

### Modulo giorno, EN Open elements

P 35 - 45 cm  
H 34.4 cm

D 13.78" - 17.72"  
H 13.54"

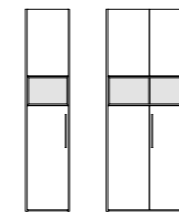

A Posizione, EN Position

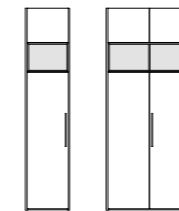

B Posizione, EN Position

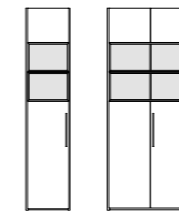

C Posizione, EN Position



# Modulo sovrapporta

## EN Over door module

### Modularità

EN Modularity

P 42.3 - 59 cm  
L 104 - 124 cm  
H 238.5 - 257.7 - 289.7 cm  
su misura

D 16.65" - 23.23"  
W 40.94" - 48.82"  
H 93.90" - 101.46" - 114.06"  
custom size

### Altezza modulo,

EN Height of module

H 38.4 - 64 cm  
H 15.12" - 25.20"

### Altezza passaggio,

EN Under-module height

H 200.4 - 219.6 - 226 cm  
H 78.90" - 86.46" - 88.98"

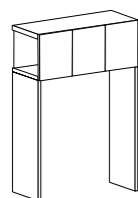
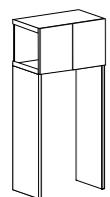

### Modelli

EN Models

Nastro\*, Raggio, Plana

\*Solo per anta vetro,  
EN Only for glass door

### Finiture Interne

EN Internal Finishes

Materico: Bianco,  
Borgogna, Canaletto,  
Rovere Laguna, Perlage  
Conchiglia, PerlageTerra

Laccato Opaco,  
EN Matt Lacquered

### Maniglie

EN Handles

Prensilità inferiore,  
EN Lower opening



# Modulo a ponte

## EN Bridge module

### Modularità

EN Modularity

P 42.3 - 59 cm  
L 104 - 124 - 144 - 154 -  
164 - 184 - 204 - 224 cm  
H 238.5 - 257.7 cm

D 16.65" - 23.23"  
W 40.94" - 48.81" - 56.69"  
- 60.63" - 64.57" - 72.44" -  
80.31" - 88.19"  
H 93.90" - 101.46"

### Altezza modulo,

EN Module height

H 64 - 96 cm  
H 25.20" - 37.80"

### Altezza sottoponte,

EN Under bridge element

H 142.8 - 162 - 174.8 -  
194 cm  
H 56.22" - 63.78" - 68.82"  
- 76.37"

### Schienale sottoponte,

EN Under bridge back panel

L 103.6 - 123.6 - 143.6 -  
153.6 - 163.6 - 183.6 - 203.6  
- 223.6 cm

W 40.78" - 48.66" - 56.53"  
- 60.47" - 64.41" - 72.28" -  
80.16" - 88.03"

\* Per dimensioni  
consultare il listino,  
EN For dimensis please  
see pricelist

### Modelli

EN Models

Nastro\*, Raggio, Plana

\*Solo per anta vetro,  
EN Only for glass door

### Finiture Interne

EN Internal Finishes

Materico: Bianco,  
Borgogna, Canaletto,  
Rovere Laguna, Perlage  
Conchiglia, PerlageTerra

Laccato Opaco,  
EN Matt Lacquered

### Maniglie

EN Handles

Prensilità inferiore,  
EN Lower opening

### Attrezzabilità

EN Accessories

Asta appendiabiti\*,  
EN Hanging rod\*

Mensole sottoponte\*,  
EN Under bridge shelves\*

Ala scrittoio, EN Ala desk

P 56.5 H 10 cm  
L 100 - 120 - 140 - 150 -  
160 - 180 cm

D 22.24" H 3.94"  
W 39.37" - 47.24" - 55.12"  
- 59.05" - 62.99" - 70.87"



# Modulo TV

## EN TV module

### Modularità

EN Modularity

P 42.3 - 59 cm  
L 104 - 124 - 144 - 154 -  
164 - 184 - 204 - 224 cm  
H 238.5 - 257.7 cm  
su misura

D 16.65" - 23.23"  
W 40.94" - 48.81" - 56.69"  
- 60.63" - 64.57" - 72.44" -  
80.31" - 88.19"  
H 93.90" - 101.46"  
custom size

### Pannelli fissi,

EN Fixed panels

L 100 - 120 - 140 - 150 -  
160 - 180 - 200 - 220 cm  
H 79.6 - 98.8 - 99.6 -  
111.6 - 118.8 cm

W 39.37" - 47.24" - 55.12"  
- 59.05" - 62.99" - 70.87"  
H 31.34" - 38.90" - 39.21"  
- 43.94" - 46.77"

### Modelli

EN Models

Nastro\*, Raggio, Plana

\*Solo per anta vetro,  
EN Only for glass door

### Finiture Interne

EN Internal Finishes

Materico: Bianco,  
Borgogna, Canaletto,  
Rovere Laguna, Perlage  
Conchiglia, PerlageTerra

Laccato Opaco,  
EN Matt Lacquered

### Maniglie

EN Handles

Prensilità inferiore,  
EN Lower opening

### Attrezzabilità

EN Accessories

Mensole, EN Shelves

L 30 P 27.5 cm  
W 11.81" D 10.83"

### Moduli Spazio,

EN Spazio modules

H 40 - 60 cm  
H 15.75" - 23.62"



# Angolo battente opposto

## EN External hinged corner module

### Modularità

EN Modularity

P 59 cm  
L 61.5 cm  
H 238.5 - 257.7 - 289.7 cm  
su misura

D 23.23"  
W 24.21"  
H 93.90" - 101.46" - 114.06"  
custom size

### Modelli

EN Models

Manhattan\*, Nastro\*,  
Tratto, Icona, Plana

\*Solo per anta legno,  
EN Only for wooden door

### Finiture Interne

EN Internal Finishes

Materico: Bianco,  
Borgogna, Canaletto,  
Rovere Laguna, Perlage  
Conchiglia, PerlageTerra

Laccato Opaco,  
EN Matt Lacquered

### Maniglie\*\*

EN Handles\*\*

A18, A39, A 84, B12, D30,  
L110, V30, V72, W40, W110,  
Y30, Y110, Push-pull

\*\* Solo per anta Plana,  
EN Only for Plana door

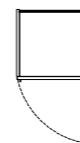

# Angolo battente

## EN Hinged corner module

### Modularità EN Modularity

L 94 x 94 P 42.3 cm  
L 110.7 x 110.7 P 59 cm  
H 238.5 - 257.7 - 289.7 cm  
su misura

W 37.01" x 37.01" P 16.65"  
W 43.58" x 43.58" P 23.23"  
H 93.90" - 101.46" - 114.06"  
custom size

### Modelli EN Models

Cornice\*, Manhattan\*,  
Milano, Nastro\*, Raggio\*,  
Tratto\*, Icona, Plana

\*No altezza 289.7 cm,  
EN Not available height  
114.06"

### Finiture Interne EN Internal Finishes

Materico: Bianco,  
Borgogna, Canaletto,  
Rovere Laguna, Perlage  
Conchiglia, PerlageTerra

Laccato Opaco,  
EN Matt Lacquered

### Maniglie\*\* EN Handles\*\*

A18, A39, A84, D30, L110,  
V30, V72, W40, W110,  
Push-pull

Serratura meccanica,  
EN Mechanical lock

\*\* Solo per anta Plana,  
EN Only for Plana door

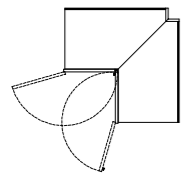

# Angolo scorrevole

## EN Sliding corner module

### Modularità EN Modularity

L 114 x 114 P 42.3 cm  
L 144 x 144 P 42.3 cm  
L 130.7 x 130.7 P 59 cm  
L 160.7 x 160.7 P 59 cm

H 238.5 - 257.7 cm  
su misura

W 44.88" x 44.88" D 16.65"  
W 56.69" x 56.69" D 16.65"  
W 51.46" x 51.46" D 23.23"  
W 63.27" x 63.27" D 23.23"

H 93.90" - 101.46"  
custom size

### Modelli EN Models

Manhattan\*, Nastro,  
Tratto, Icona, Plana

\*Solo per anta legno,  
EN Only for wooden door

### Finiture Interne EN Internal Finishes

Materico: Bianco,  
Borgogna, Canaletto,  
Rovere Laguna, Perlage  
Conchiglia, PerlageTerra

Laccato Opaco,  
EN Matt Lacquered

### Maniglie\*\* EN Handles\*\*

A18, A39, A 84, D30, L110,  
V30, V72, W40, W110

\*\* Solo per anta Plana,  
EN Only for Plana door

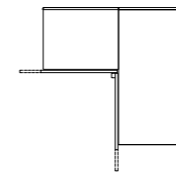

# Cabina angolare a soffietto

## EN Folding door corner dressing closet

Modularità EN Modularity	Modelli EN Models	Finiture Interne EN Internal Finishes	Maniglie** EN Handles**	Attrezzabilità EN Accessories
P 59 cm L 131 x 131 cm H 238.5 - 257.7 cm su misura	Cornice, Tratto, Icona, Plana	Materico: Bianco, Borgogna, Canaletto, Rovere Laguna, Perlage Conchiglia, PerlageTerra	A18, A39, A84, V30, V72, D30, B12  ** Solo per anta Plana, EN Only for Plana door	Appendini e vaschetta in alluminio, EN Aluminium hangers and metal tray  Specchio fisso, EN Fixed mirror L 36 H 180cm W 14.17" H 70.87"  Specchio orientabile, EN Swiveling mirror L 33 H 140 cm W 12.99" H 55.12"

È possibile accostare ante battenti o scorrevoli Plana, Tratto, Icona, Manhattan, Nastro, Raggio, Crea, Vitrum, Vela,  
EN It is possible to combine hinged door modules with sliding door modules for Plana, Tratto, Icona, Manhattan, Nastro, Raggio, Crea, Vitrum, Vela

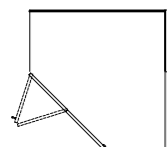

# Cabina terminale a soffietto

## EN Folding door terminal dressing closet

Modularità EN Modularity	Modelli EN Models	Finiture Interne EN Internal Finishes	Maniglie** EN Handles**	Attrezzabilità EN Accessories
P 59 cm L 131 x 134 cm H 238.5 - 257.7 cm su misura	Cornice, Tratto, Icona, Plana	Materico: Bianco, Borgogna, Canaletto, Rovere Laguna, Perlage Conchiglia, PerlageTerra	A18, A39, A84, V30, V72, D30, B12  ** Solo per anta Plana, EN Only for Plana door	Appendini e vaschetta in alluminio, EN Aluminium hangers and metal tray  Specchio fisso, EN Fixed mirror L 36 H 180cm W 14.17" H 70.87"  Specchio orientabile, EN Swiveling mirror L 33 H 140 cm W 12.99" H 55.12"

È possibile accostare ante battenti o scorrevoli Plana, Tratto, Icona, Manhattan, Nastro, Raggio, Crea, Vitrum, Vela,  
EN It is possible to combine hinged door modules with sliding door modules for Plana, Tratto, Icona, Manhattan, Nastro, Raggio, Crea, Vitrum, Vela

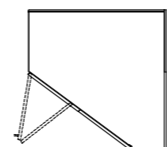

# Terminale a giorno

## EN Open terminal module

### Modularità EN Modularity

P 59 cm  
L 30.5 cm  
H 238.5 - 257.7 cm

D 23.23"  
W 11.81"  
H 93.90" - 101.46"

### Modelli EN Models

Accostabile a tutti i modelli battente, scorrevole, complanare,  
EN It can be combined with all hinged, sliding and flush sliding door modules

### Finiture EN Finishes

Materico: Bianco, Borgogna, Canaletto, Rovere Laguna, Perlage Conchiglia, PerlageTerra

Laccato Opaco,  
EN Matt Lacquered

### Attrezzabilità EN Accessories

Asta appendiabiti,  
EN Hanging rods

Ripiani, EN Shelves



# Terminale a scrigno

## EN Module with L-shaped opening

### Modularità EN Modularity

P 59 cm  
L 34.5 cm  
H 238.5 - 257.7 cm

D 23.23"  
W 13.58"  
H 93.90" - 101.46"

### Modelli EN Models

Cornice\*, Plana\*\*

\*Solo per anta legno (no materico) e pelle sintetica, EN Only for wooden door (not available in materico) and synthetic leather

\*\*No materico, EN Not available in materico

### Finiture Interne EN Internal Finishes

Materico: Bianco, Borgogna, Canaletto, Rovere Laguna, Perlage Conchiglia, PerlageTerra

Laccato Opaco,  
EN Matt Lacquered

### Maniglie\*\* EN Handles\*\*

A18, A39, A84, B12, D30, L110, W40, W110, Y30, Y110

\*\* Solo per anta Plana,  
EN Only for Plana door

### Attrezzabilità EN Accessories

Asta appendiabiti,  
EN Hanging rods

Ripiani, EN Shelves

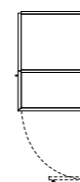

# Pannelli per modulo centrostanza

## <sup>EN</sup> Panels for all-side finished modules

### Modularità <sup>EN</sup> Modularity

L da 30 a 122.7 cm  
H 238.5 - 257.7 - 289.7 cm

D 23.23"  
W from 11.81" to 48.31"  
H 93.90" - 101.46" - 114.05"

### Modelli <sup>EN</sup> Models

Battente lineare,  
<sup>EN</sup> Linear hinged door

Scorrevole lineare,  
<sup>EN</sup> Linear sliding door

Solo per modulo sovrapporta,  
<sup>EN</sup> Only for over door module

No moduli angolari,  
<sup>EN</sup> Except for corner modules

### Finiture <sup>EN</sup> Finishes

Laccato Opaco o Lucido,  
<sup>EN</sup> Matt or High Gloss  
Lacquered, +RAL, Soft  
Touch, Alaska Laccato,  
<sup>EN</sup> Alaska Lacquered

Essenza, <sup>EN</sup> Wood:  
Borgogna, Canaletto,  
Rovere Fumo, Rovere  
Grigio, Rovere Laguna  
Rovere Naturale, Rovere  
Tabacco

Materico: Bianco, Cenere,  
Seta, Alaska, Corsica

Vetro, <sup>EN</sup> Glass:  
Laccato Opaco o Lucido,  
<sup>EN</sup> Matt or Glossy  
Lacquered, +RAL,  
Metallizzato Bronzo

Specchio, <sup>EN</sup> Mirror:  
Argento, Fumé, Piombo



**Attrezzatura**  
**EN Accessories**

# Ripiani

## EN Shelves

### Tipologie

#### EN Types

**01**  
Ripiano in legno\*,  
EN Wooden shelf\*  
Sp 4 cm, Th 1.57"

P 39.5 - 51.1 cm  
L 37.8 - 47.8 - 57.8 - 67.8  
77.8 - 97.8 - 117.8 - 128.8  
137.8 - 147.8 cm

D 15.55" - 20.12"  
W 14.88" - 18.81" - 22.76"  
26.69" - 30.63" - 38.50"  
46.38" - 50.71" - 54.25"  
58.19"

Angolo, EN Corner  
Terminale, EN Terminal

**02**  
Ripiano in pelle sintetica  
con bordo in materico\*,  
EN Synthetic leather shelf  
with materico edge\*  
Sp 4 cm, Th 1.57"

P 39.5 - 51.1 cm  
L 37.8 - 47.8 - 57.8 - 67.8  
77.8 - 97.8 - 117.8 - 128.8  
137.8 - 147.8 cm

D 15.55" - 20.12"  
W 14.88" - 18.81" - 22.76"  
26.69" - 30.63" - 38.50"  
46.38" - 50.71" - 54.25"  
58.19"

**03**  
Ripiano in vetro fumè  
EN Fumé glass shelf,  
Sp 1.2 cm, Th 0.47"

P 39.5 - 51.1 cm  
L 37.8 - 47.8 - 57.8 - 67.8  
- 77.8 - 97.8 - 117.8 cm

D 15.55" - 20.12"  
W 14.88" - 18.82" - 22.75"  
- 26.69" - 30.63" - 38.50"  
- 46.38"

**04**  
Ripiano in vetro con telaio  
in legno con luce led,  
EN Glass shelf with wooden  
frame and LED light  
Sp 4 cm, Th 1.57"

P 51.1 cm  
L 47.8 - 57.8 - 67.8 - 97.8  
117.8 cm

D 20.12"  
W 18.81" - 22.76" - 26.69"  
38.50" - 46.38"



01



03

\* Disponibile anche  
versione a tutta profondità  
per moduli P 42.3 - 59 cm,  
EN Full-depth version  
available for D 16.65" -  
23.23"

### Finiture

#### EN Finishes

Materico: Bianco,  
Borgogna, Canaletto,  
Rovere Laguna, Perlage  
Conchiglia, PerlageTerra

Laccato Opaco,  
EN Matt Lacquered

Pelle Sintetica,  
EN Synthetic Leather:  
Creta, Elephant, Talpa

Vetro, EN Glass:  
Fumé



02



04

# Divisori interni

## EN Internal partitions

### Modularità

#### EN Modularity

**Divisori a tutta altezza,**  
EN Full height partitions

P 39.5 - 51.1 cm  
H 238.5 - 257.7 - 289.7 cm

D 15.55" - 20.12"  
H 93.90" - 101.46" - 114.05"

**Divisori da base per  
moduli battenti, cabina  
soffietto, EN Partitions fixed  
on the base for hinged  
door modules, folding door  
dressing closet**

P 39.5 - 51.1 cm  
H 46 - 78 - 110 - 142 - 174  
206 - 238 cm

D 15.55" - 20.12"  
H 18.11" - 30.71" - 43.31" -  
55.91" - 68.50" - 81.10" -  
93.70

**Divisori da base per  
moduli scorrevoli, moduli  
complanari, EN Partitions  
fixed on the base for  
sliding and flush sliding  
door modules**

P 39.5 - 51.1 cm  
H 41 - 73 - 105 - 137 - 169  
201 - 233 cm

D 15.55" - 20.12"  
H 16.14" - 28.74" - 41.34"  
53.94" - 66.54" - 79.13"  
91.73"

Presentano un'impronta  
ogni 6.4 cm per il  
posizionamento dei  
ripiani spostabili,  
EN They have a mark every  
2.52" for positioning  
movable shelves

### Finiture

#### EN Finishes

Materico: Bianco,  
Borgogna, Canaletto,  
Rovere Laguna, Perlage  
Conchiglia, PerlageTerra

Laccato Opaco,  
EN Matt Lacquered



# Cassettiere

## EN Drawer units

### Informazioni EN Informations

Sono disponibili elementi interi a uno, due, tre cassetti. Con la sovrapposizione tra loro si possono ottenere multipli a quattro, cinque, sei cassetti. Tutti i cassetti sono dotati di guida invisibile con carrello di scorrimento a rulli, richiamo automatico di chiusura, fermo antisgancio e ammortizzatore di chiusura

EN One, two and three-drawer modules are available. Simply by stacking the modules it is possible to create modules with four, five or six drawers. Drawers are equipped with invisible glides with rollers, soft closing a safety locking device.

**01**  
A terra, EN Floor sitting

**02**  
Pensili, EN Suspended

**03**  
Con elementi a T con vano superiore, EN T elements with upper compartment

**04**  
Con elementi a T di pari altezza, EN T elements with the same height

### Finiture EN Finishes

Materico: Bianco, Borgogna, Canaletto, Rovere Laguna, Perlage Conchiglia, PerlageTerra

Laccato Opaco, EN Matt Lacquered

### Finiture Top EN Top Finishes

Materico: Bianco, Borgogna, Canaletto, Rovere Laguna, Perlage Conchiglia, PerlageTerra

Laccato Opaco, EN Matt Lacquered

Pelle sintetica, EN Synthetic Leather: Creta, Elephant, Talpa

### Attrezzabilità EN Accessories

Telaio estraibile, EN Pull-out tray

Serratura elettronica, EN Electronic lock

Accessori pag. 284  
EN Accessories pag. 284



01



03



02



04

# Frontali cassetti

## EN Drawer fronts

### Modularità EN Modularity

**01**  
Legno, EN Wood  
H 9 - 18 - 36 cm  
H 3.54" - 7.09" - 14.17"

**02**  
Vetro, EN Glass  
H 18 - 36 cm  
H 7.09" - 14.17"

**03**  
Con oblò, EN See-through glass front  
H 18 cm, H 7.09"

**04**  
Pelle sintetica, EN Synthetic Leather  
H 18 - 36 cm  
H 7.09" - 14.17"

### Finiture EN Finishes

Materico: Bianco, Borgogna, Canaletto, Rovere Laguna, Perlage Conchiglia, PerlageTerra

Laccato Opaco, EN Matt lacquered

Vetro, EN Glass:  
Laccato Opaco o Lucido, EN Matt or Glossy  
Lacquered

Con oblò, EN See-through glass front:  
Extrachiaro Trasparente con cornice Bianco, Fumé con cornice Nero, EN Extrachiaro Trasparente with White frame, Fumé with Black frame

Pelle Sintetica, EN Synthetic Leather:  
Creta, Elephant, Talpa

### Finiture girocassetto EN Drawer frame finishes

Materico Argento con fondo Piombo, EN Materico Argento with Piombo bottom



01



03



02



04

# Cassettiere a terra

## EN Floor sitting drawer units

**Modularità**  
EN Modularity

L 57.8 - 67.8 - 97.8 - 117.8  
137.8 - 147.8 cm  
P 36.1\* - 53 cm  
H 43 - 64 - 81 - 103 -  
120 cm

W 22.76" - 26.69" - 38.50"  
46.38" - 54.25" - 58.19"  
D 14.21"\* - 20.87"  
H 16.93" - 25.20" - 31.89"  
- 40.55" - 47.24"

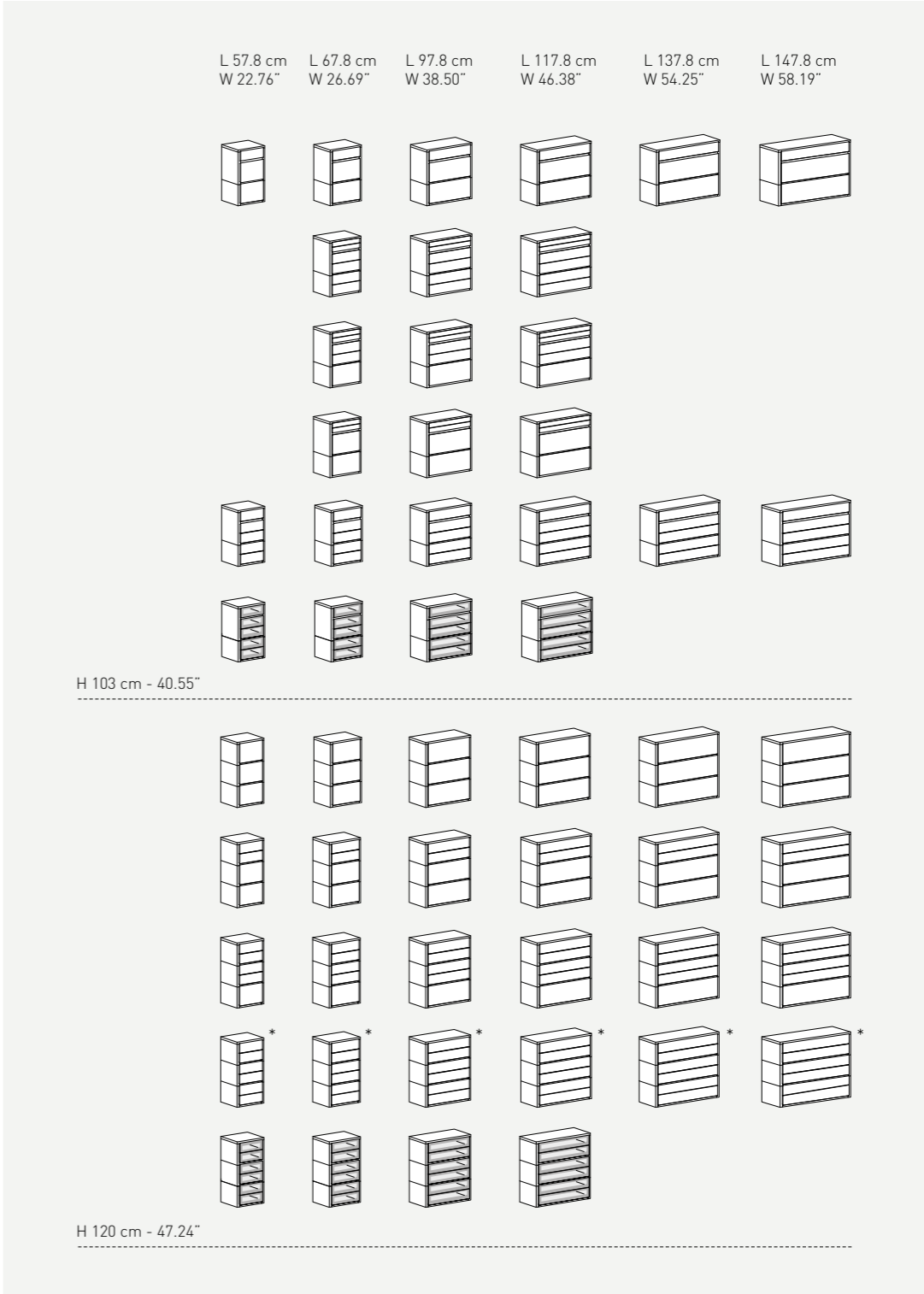
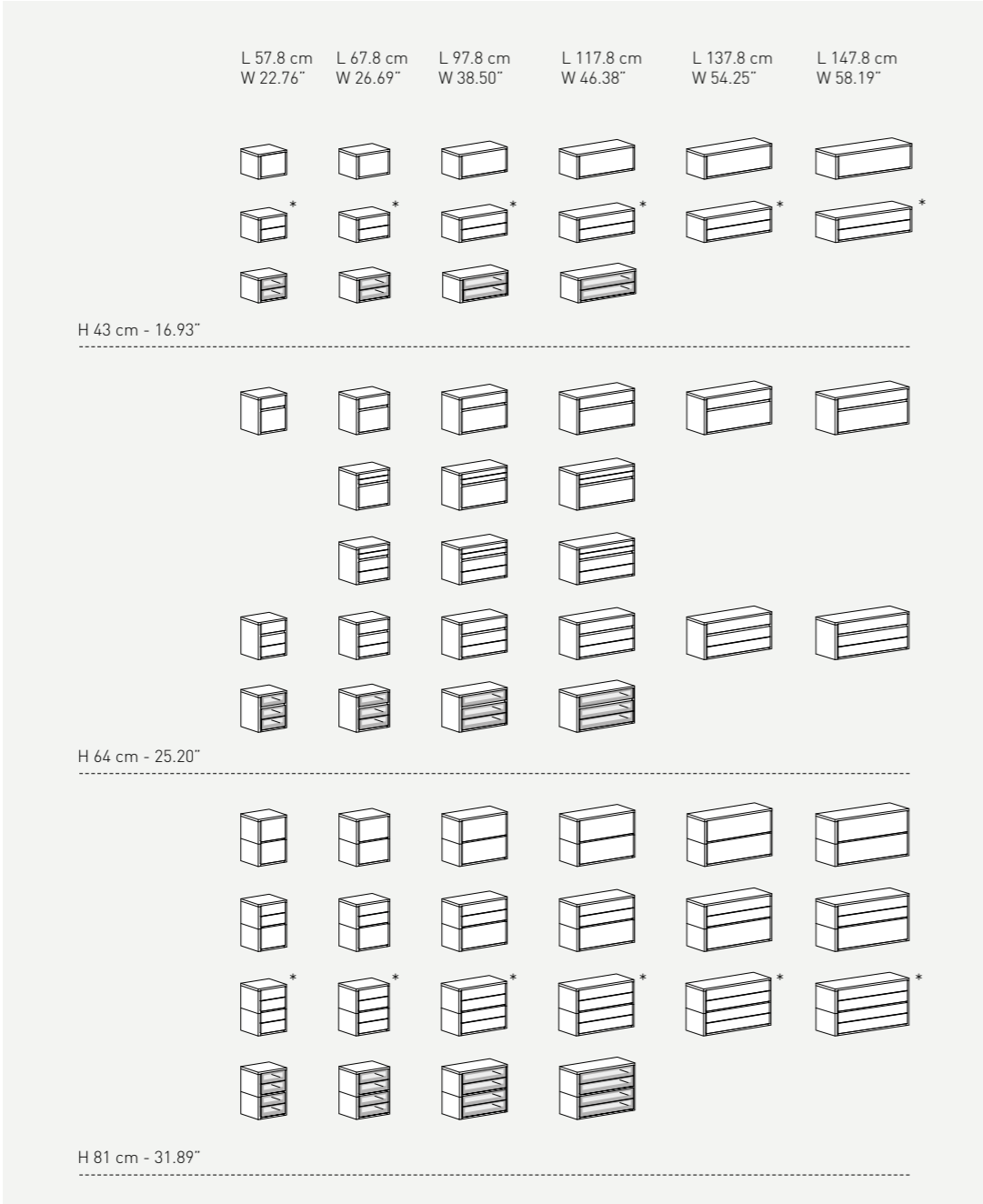

# Cassettiere sospese

## EN Suspended drawer units

### Modularità

#### EN Modularity

L 57.8 - 67.8 - 97.8 - 117.8  
137.8 - 147.8 cm  
P 53 cm  
H 22 - 38 cm

W 22.76" - 26.69" - 38.50"  
46.38" - 54.25" - 58.19"  
D 20.87"  
H 8.66" - 14.96"

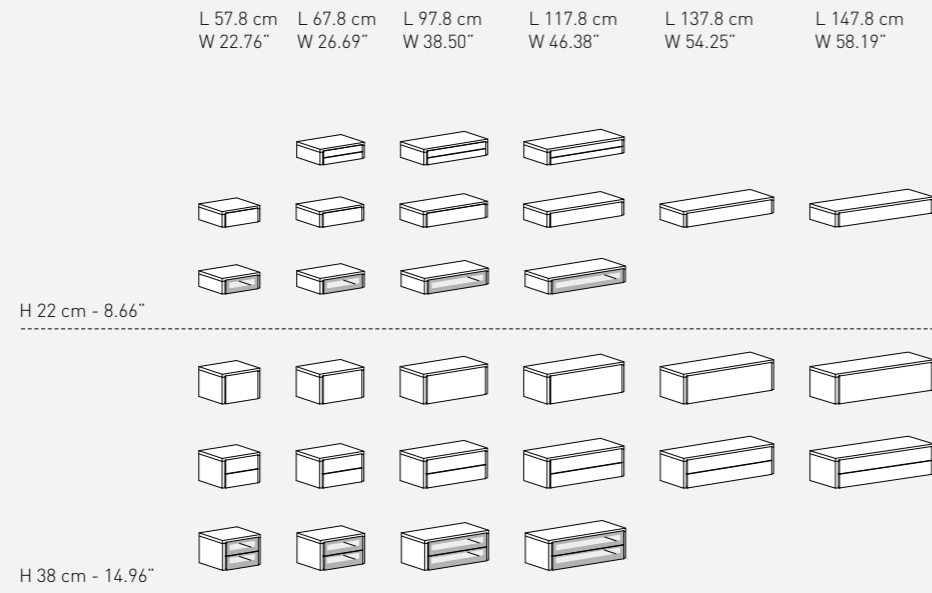

# Raster legno

## EN Wooden cubbies

### Modularità

#### EN Modularity

L 67.8 - 97.8 - 117.8 cm  
P 34.4 - 51.1 cm  
H 43 - 62 - 68 - 87 cm

W 26.69" - 38.50" - 46.38"  
D 13.54" - 20.12"  
H 16.93" - 24.41" - 26.77"  
- 34.25"

### Contenitori per raster

#### EN Boxes for cubbies

L 28.2 - 43.2 - 53.2 cm  
P 50.5 cm  
H 14 cm

W 11.10" - 17.01" - 20.94"  
D 19.88"  
H 5.51"

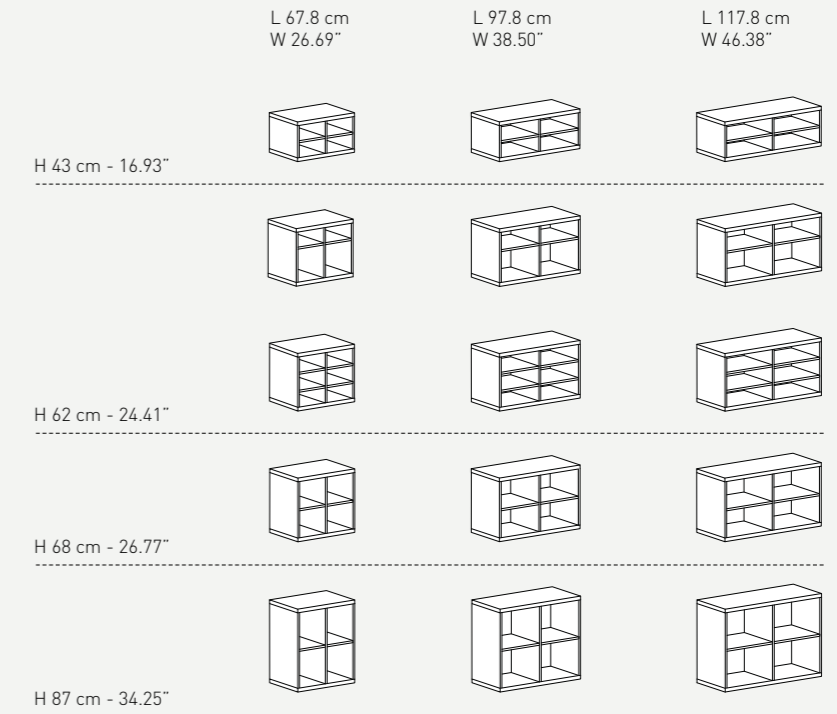

# Elemento T per cassettiere

## EN T partition for drawer units

### Modularità EN Modularity

L 97.8 - 117.8 - 128.8 -  
137.8 - 147.8 cm  
P 34.4 - 42.3\* - 51.1 cm  
H 42.4 - 63.7 - 81 - 103 cm

W 38.50" - 46.38" - 50.71"  
- 54.25" - 58.19"  
D 13.54" - 16.65\*\* - 20.12"  
H 16.69" - 25.08" - 31.89"  
- 40.55"

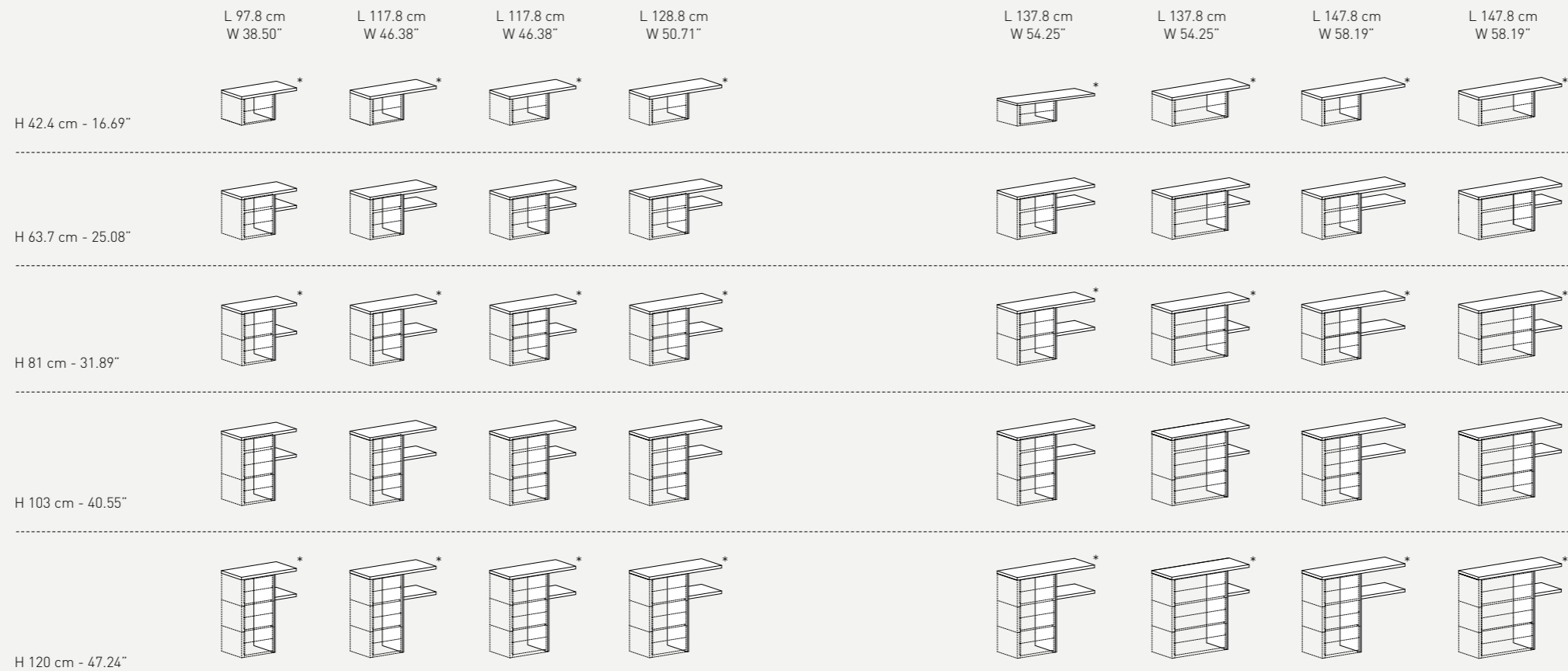

# Appenderia

## EN Hangers

### Tipologie EN Types

#### 01 Servetto estraibile, EN Pull-down rod

L 67.8 - 97.8 - 117.8 cm  
W 26.69" - 38.50" - 46.38"

Finitura, EN Finish  
Brown

#### 02 Asta appendiabiti, EN Hanging rod

L 37.8 - 47.8 - 57.8 - 67.8  
97.8 - 117.8 - 137.8 -  
147.8 cm

W 14.88" - 18.81" - 22.76"  
26.69" - 38.50" - 46.38"  
54.25" - 58.19"

Finitura, EN Finish  
Manganese

#### 03 Asta appendiabiti estraibile, EN Pull-out hanging rod

P 36 cm, D 14.17"

Finitura, EN Finish  
Cromo



01



02



03

### Tipologie EN Types

#### 04 Portacinture, portacravatte da applicare al fianco, divisorio, EN Tie, belt holder for side, partition

P 50 cm D 19.69"

Finitura, EN Finish  
Brown

#### 05 Portacravatte, EN Belt holder

L 11 P 36.5 cm  
W 4.33" D 14.37"

Finitura, EN Finish  
Pelle sintetica,  
EN Synthetic leather:  
Elephant

#### 06 Pomolo estraibile incassato nel ripiano, EN Pull-out knob recessed inside the shelf

P 10.9 cm ø 2 cm  
D 4.29" ø 0.79"

Finitura, EN Finish  
Cromo

#### 07 Pomolo estraibile esterno, EN Pull-out knob external

P 17.6 cm ø 2 cm  
D 6.93" ø 0.79"

Finitura, EN Finish  
Cromo



04



05



06



07

# Cassetti attrezzati con telai estraibili

## EN Drawers equipped with pull-out frames

### Dimensioni EN Dimensions

L 67.8 - 97.8 - 117.8 cm  
P 48 cm

W 26.69" - 38.50" - 46.38"  
D 18.90"

Finitura telaio,  
EN Frame finish  
Manganese

### Soluzioni per frontali con telai estraibili EN Drawer fronts with pull-out frame

I telai estraibili vengono fissati al frontale del cassetto in sostituzione del girocassetto

EN Pull-out trays are fixed to the drawer front replacing the regular drawer frame

### Attrezzabile con: EN Equipped with:

#### 01

Soluzioni cassettiere con telai estraibili in metallo. Frontale H 9 cm,  
EN Drawer units with metal pull-out frames. Front H 3.54"

A terra, EN Floor sitting  
A - B Vassoio, EN Tray

Pensile, EN Suspended  
A Vassoio, EN Tray  
B Vassoio, portapantaloni, sacche portabiancheria, EN Tray, trouser rack, hampers

#### 02

Soluzione cassettiere con telai estraibili in metallo Frontale H 18 cm,  
EN Drawer units solution with metal pull-out frames Front H 7.09"

A terra, EN Floor sitting  
A - B Vassoio, piano in legno o vetro, EN Tray, wooden or glass shelf

Pensile, EN Suspended  
A - B Vassoio, piano in legno o vetro, EN Tray, wooden or glass shelf

C Vassoio, piano in legno o vetro, portapantaloni, portagonne, sacche portabiancheria, EN Tray, wooden or glass shelf, trousers rack, skirt rack, hampers

#### 03

Soluzione cassettiere con telai estraibili in metallo e girocassetto legno. Frontale H 36 cm,  
EN Drawer units solution with metal pull-out frames and wooden drawer frame. Front H 14.17"

A terra o Pensile, EN Floor sitting or suspended  
A - B Vassoio, EN Tray



01 Cassetti chiusi, EN Closed drawers



Cassetti aperti, EN Open drawers



02 Cassetti chiusi, EN Closed drawers



Cassetti aperti, EN Open drawers



03 Cestone chiuso, EN Closed tall drawer



Cestone aperto, EN Open tall drawer

# Telai estraibili e accessori

## EN Pull-out frames and accessories

### Tipologie EN Types

#### 01 Vassoio metallo, EN Metal tray

H 6 cm - 2.36"

Finitura, EN Finish  
Manganese

#### 02 Piano vetro Fumé, EN Fumé glass shelf

H 6 cm - 2.36"

#### 03 Piano in legno, EN Wooden shelf

H 6 cm - 2.36"

Finiture, EN Finishes  
Materico: Bianco,  
Borgogna, Canaletto,  
PerlageTerra, Perlage  
Conchiglia, Rovere Fumo

Laccato Opaco,  
EN Matt lacquered

#### 04 Griglia per vassoio, EN Grid for tray

H 6 cm - 2.36"

Finitura, EN Finish  
Manganese

#### 05 Portapantaloni + vaschetta, non disponibile L 67.8 cm, EN Trousers rack + tray, not available W 26.69"

H 6 cm - 2.36"

### Soluzioni con telaio EN Pull-out frame solutions

I telai estraibili vengono fissati direttamente alla struttura dell'armadio grazie ai distanziali in legno e sono finiti anteriormente da un frontalino H 5.8 cm in legno

EN The pull-out trays are fixed to the wardrobe structure thanks to wooden spacers and they are equipped with a H 2.30" wooden front

### Dimensioni EN Dimensions

L 67.8 - 97.8 - 117.8 cm  
P 48 cm

W 26.69" - 38.50" - 46.38"  
D 18.90"

Finitura telaio, EN Frame  
finish: Manganese

### Tipologie EN Types

#### 06 Portapantaloni + portagonne, non disponibile L 67.8 cm, EN Trousers rack + skirt rack, not available W 26.69"

H 6 cm - 2.36"

Finitura, EN Finish  
Manganese

#### 07 Portapantaloni, EN Trousers rack

H 6 cm - 2.36"

Finitura, EN Finish  
Manganese

#### 08 Portagonne, EN Skirt rack

H 6 cm - 2.36"

Finitura, EN Finish  
Manganese

#### 09 Scarpiera in metallo, EN Metal shoe rack

H 15 cm - 5.91"

Finitura, EN Finish  
Manganese

#### 10 Sacche portabiancheria in tessuto trapuntato, EN Hampers in tufted fabric

H 31 cm - 12.20"



05



06



01



02



07



08



03



04



09



10

# Portascarpe

## EN Shoe rack

### Tipologie

#### EN Types

01

Portascarpe fisso,  
EN Fixed shoe rack

L da 57.8 a 67.8 cm  
P 22 cm

W from 22.76" to 26.69"  
D 8.66"

Finitura, EN Finish  
Brown



01

02

Portascarpe estraibile  
Basic con vaschetta,  
EN Basic pull-out shoe  
rack with tray

P 50 cm  
L 67.8 - 97.8 cm

D 19.69"  
W 26.69" - 38.50"

Finitura, EN Finish  
Brown



03

03

Ripiano inclinato,  
EN Inclined shelf

Sp 4 cm, Th 1.57"

P 39.5 - 51.1 cm  
L 37.8 - 47.8 - 57.8 - 67.8 -  
77.8 - 97.8 - 117.8 - 137.8  
147.8 cm

D 15.55" - 20.12"  
W 14.88" - 18.81" - 22.76"  
26.69" - 30.63 - 38.50" -  
46.38" 54.25" - 58.19"

# Cassettiere su ruote

## EN Drawer units on castors

### Modularità

#### EN Modularity

Cassettiere autoportanti  
con ruote, EN Drawer unit  
on castors

L 50 - 70 - 90 - 110 cm  
H 44 - 82 cm

W 19.69" - 27.56" - 35.43"  
43.31"  
H 17.32" - 32.28"



# Accessori

## EN Accessories

### Tipologie

#### EN Types

#### 01 Appendiera, EN Hangers

Anello grande portasciarpe, foulard e borse, <sup>EN</sup> Large ring hanger for scarves and bags

Anello piccolo portacravatte o cinture, <sup>EN</sup> Small ring hanger for ties and belts

Bastone prendiabiti, <sup>EN</sup> Rod

**01a**  
Gruccia capospalla uomo con portapantaloni, <sup>EN</sup> Man hanger with trouser hanger

Gruccia portapantaloni, <sup>EN</sup> Trousers hanger

**01b**  
Gruccia capospalla donna con portagonna, <sup>EN</sup> Woman hanger with skirt hanger

Gruccia portagonna, <sup>EN</sup> Skirt hanger

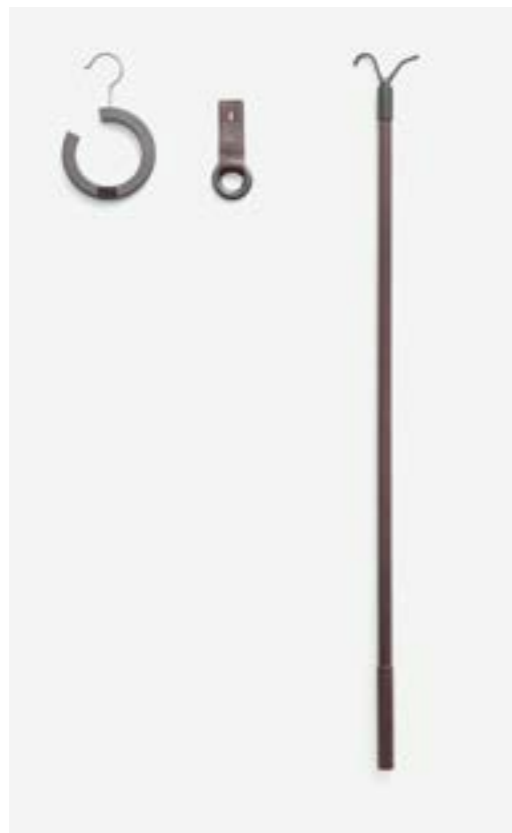

01



01a



01b

### Tipologie

#### EN Types

#### 01 Scatole con coperchio, EN Boxes with lid

L 26 - 40 cm H 40 cm  
W 10.24" - 15.75" H 15.75"

**02**  
Vassoio e vassoio con griglia portafoulard, cravatte, cinture, <sup>EN</sup> Standard tray and basic tray with scarves, ties and belt dividers

L 45.5 P 39 H 6 cm  
W 17.91" D 15.35" H 2.36"

**03**  
Svuotatasche: Possono essere inseriti nei cassetti e vassoi, <sup>EN</sup> Valet trays: they can be inserted in drawers and pull-out trays

P 22.1 L 18.8 H 4 cm  
W 8.70" D 7.40" H 1.58"

#### **05** Fondo per cassetti EN Drawer mat

Sipario:  
L 67.8 - 97.8 - 117.8 - 137.8 - 147.8 cm  
W 26.69" - 38.50" - 46.38" - 54.25" - 58.19"

Anteprima, Island:  
L 49.3 - 69.3 - 89.3 - 109.3 cm  
W 19.41" - 27.28" - 35.16" - 43.03"

Finiture, <sup>EN</sup> Finishes  
Pelle sintetica, <sup>EN</sup> Synthetic Leather:  
Creta, Elephant



01



02



03



05



05

**A**  
Porta anelli - orecchini, <sup>EN</sup> Rings and earrings tray

**B**  
Portagioie, <sup>EN</sup> Jewellery tray

**C**  
Porta orologio, <sup>EN</sup> Wrist watch tray

**D**  
Porta bracciali, <sup>EN</sup> Bracelets tray

# Specchi

## EN Mirrors

### Tipologie

#### EN Types

**01**  
Specchio estraibile ed orientabile applicabile al fianco scorrevole o complanare, <sup>EN</sup> Pull-out and swiveling mirror attached to the side of sliding and flush sliding door wardrobes

L 33 cm H 140 cm  
W 12.99" H 55.12"

**02**  
Specchio orientabile applicabile al fianco, <sup>EN</sup> Swiveling mirror attached to the side

L 33 cm H 140 cm  
W 12.99" H 55.12"

**03**  
Specchio fisso applicabile all'anta battente, <sup>EN</sup> Fixed mirror attached to the back of hinged doors

L 36 cm H 180 cm  
W 14.17" H 70.87"

**04**  
Specchio fianco di finitura, <sup>EN</sup> Mirror side

L 42.3 - 59 cm  
W 16.65" - 23.23"



01



02



03



04

# Illuminazione

## EN Lighting

### Tipologie

#### EN Types

**01**  
Luci led verticali per moduli armadio dotate di sensore di presenza per l'accensione, <sup>EN</sup> Vertical LED lights for wardrobe modules with motion sensor

H 238.5 - 257.7 - 289.7 cm  
93.90" - 101.46" - 114.06"  
Su misura, <sup>EN</sup> Custom size

**02**  
Luci led orizzontali per ripiani e cappelli ad incasso dotate di sensore di presenza per l'accensione, <sup>EN</sup> Horizontal recessed LED lights for shelves and tops with motion sensor

L 47.8 - 57.8 - 67.8 - 97.8 - 117.8 137.8 - 147.8 cm  
W 18.81" - 22.76" - 26.69" - 38.50" - 46.38"

Per ripiano per cabina soffietto, <sup>EN</sup> For shelf folding door closet

L 128.8 cm - W 50.71"

Per angolo scorrevole e battente, <sup>EN</sup> For sliding and hinged door corner

**03**  
Ripiano con luce, inserita all'interno del telaio e sensore di presenza per l'accensione, <sup>EN</sup> Shelf with LED light inserted in the frame with motion sensor

L 47.8 - 57.8 - 67.8 - 97.8 - 117.8 cm  
W 18.81" - 22.76" 26.69" - 38.50" - 46.38"



01



02



03

# Allestimenti interni

## EN Interior configurations



**AL**

1 Asta appendiabiti,  
EN Hanging rods

6 Ripiani legno Sp 4 cm,  
EN Wooden shelves 1.57" Th

1 Divisorio interno  
H 201 cm, EN Internal  
partition H 79.13"

1 Portapantaloni estraibile,  
EN Pull-out trouser rack



**AD**

2 Aste appendiabiti,  
EN Hanging rods

1 Ripiano legno Sp 4cm,  
EN Wooden shelf 1.57" Th

2 Ripiani legno estraibili,  
EN Pull-out wooden shelves

1 Cassettiera a terra  
H 81 cm, EN Floor sitting  
drawer unit H 31.90"

1 Divisorio interno  
H 105 cm, EN Internal  
partition H 41.30"



**AA**

2 Aste appendiabiti,  
EN Hanging rods

2 Ripiani legno Sp 4 cm,  
EN Wooden shelves 1.57"Th

1 Cassettiera a terra  
H 81 cm, EN Floor sitting  
drawer unit H 31.89"

1 Divisorio interno  
H 174 cm, EN Internal  
partition H 68.50"



**AN**

2 Ripiani legno Sp 4 cm,  
EN Wooden shelves 1.57"Th

1 Cassettiera pensile  
H 22 cm, EN Suspended  
drawer unit H 8.66"

1 cassettiera a terra  
H 38 cm, EN Floor sitting  
drawer unit H 14.96"



**AQ**

1 Asta appendiabiti,  
EN Hanging rod

1 Ripiani legno Sp 4 cm,  
EN Wooden shelves  
1.57" Th

1 Cassettiera a terra  
H 64 cm, EN Floor-sitting  
drawer unit H 25.20"

1 Raster legno H 43 cm,  
EN Wooden cubby H 16.93"



**AF**

2 Aste appendiabiti,  
EN Hanging rods

1 Ripiani legno Sp 4 cm,  
EN Wooden shelf  
1.57" Th

1 Cassettiera a terra  
H 64 cm, EN Floor-sitting  
drawer unit H 25.20"

1 Raster legno H 43 cm,  
EN Wooden cubby H 16.93"

1 Divisorio interno  
H 137 cm, EN Internal  
partition H 53.94"



**AB**

1 Asta appendiabiti,  
EN Hanging rod

4 Ripiani legno sp 4 cm,  
EN Wooden shelves 1.57"Th

3 Ripiani portascarpe,  
EN Shoe rack shelves

1 Cassettiera a terra  
H 103 cm, EN Floor-sitting  
drawer unit H 40.55"

1 Divisorio interno  
H 250 cm, EN Internal  
partition H 98.43"



**AP**

1 Asta appendiabiti,  
EN Hanging rod

1 Ripiano legno Sp 4 cm,  
EN Wooden shelf 1.57"Th

1 cassettiera a terra  
H 103 cm, EN Floor sitting  
drawer unit H 40.55"

**Lavorazioni su misura**  
**EN Made to measure solutions**

# Riduzioni in altezza

## EN Height reduction

---

### Modelli

EN Models

---

#### Battente,

EN Hinged door

Cornice, Manhattan,  
Milano, Nastro, Raggio,  
Tratto, Icona, Plana

#### Scorrevole,

EN Sliding door

Cornice, Manhattan,  
Nastro, Raggio, Tratto,  
Icona, Plana

#### Complanare,

EN Flush sliding door

Cornice, Nastro, Raggio,  
Icona, Plana



# Riduzione in larghezza

## EN Width reduction

---

### Modelli

EN Models

---

#### Battente,

EN Hinged door

Cornice, Manhattan,  
Milano, Nastro, Tratto,  
Icona, Plana

#### Scorrevole,

EN Sliding door

Cornice\*, Nastro\*, Icona,  
Plana

Legno, EN Wood:  
Cornice, Nastro

\*Solo per anta legno,  
EN Only for wooden door



Non sono riducibili  
aperture complanari,  
moduli terminali battenti,  
cabine soffietto,  
EN It is not possible to  
reduce flush sliding door  
modules, terminal hinged  
door modules, folding  
door dressing closets

# Riduzioni in profondità

## <sup>EN</sup> Depth reduction

---

### Modelli

<sup>EN</sup> Models

---

#### Battente,

<sup>EN</sup> Hinged door

Disponibile per tutte le ante battenti,  
<sup>EN</sup> Available for all hinged doors

#### Scorrevole,

<sup>EN</sup> Sliding door

Disponibile per tutte le ante scorrevoli,  
<sup>EN</sup> Available for all sliding doors



Non sono riducibili aperture complanari e moduli terminali battenti,  
<sup>EN</sup> It is not possible to reduce flush sliding door modules

# Riduzione per pilastri e travi

## <sup>EN</sup> Pillar and beam solutions

---

### Modelli

<sup>EN</sup> Models

---

#### Battente,

<sup>EN</sup> Hinged door

Disponibile per tutte le ante battenti,  
<sup>EN</sup> Available for all hinged doors

#### Scorrevole,

<sup>EN</sup> Sliding door

Disponibile per tutte le ante scorrevoli,  
<sup>EN</sup> Available for all sliding doors



Non sono riducibili aperture complanari e moduli terminali battenti,  
<sup>EN</sup> It is not possible to reduce flush sliding door modules and terminal hinged door modules

# Fasce di tamponamento

## EN Fillers

### Modelli

EN Models

#### Battente,

EN Hinged door

Disponibile per tutte le ante battenti,  
EN Available for all hinged doors

#### Scorrevole,

EN Sliding door

Disponibile per tutte le ante scorrevoli,  
EN Available for all sliding doors

#### Complanare,

EN Flush Sliding door

Disponibile per tutte le ante complanari,  
EN Available for all flush sliding doors

### Finiture

EN Finishes

Laccato Opaco o Lucido,  
EN Matt or High Gloss  
Lacquered

+RAL, Soft Touch

Essenza, EN Wood:  
Borgogna, Canaletto,  
Rovere Fumo, Rovere  
Grigio, Rovere Laguna  
Rovere Naturale, Rovere  
Tabacco

Materico: Bianco, Cenere,  
Seta, Alaska, Corsica



# Tamponamenti ad anta

## EN Fillers doors

### Modelli

EN Models

Cornice, Manhattan,  
Nastro, Tratto, Icona,  
Plana

Tamponamento laterale  
apribile ad anta battente  
può essere accostato  
anche a moduli con anta  
scorrevole,  
EN Hinged side filler can  
be combined to sliding  
door modules

#### Tamponamento superiore\*,

EN Top filler\*

**01**  
Battente, EN Hinged doors  
Cornice, Manhattan,  
Nastro, Tratto, Icona,  
Plana

\*Solo per anta legno,  
EN Only for wooden door

**02**  
Scorrevole, EN Sliding door  
Cornice, Manhattan,  
Nastro, Tratto, Icona,  
Plana

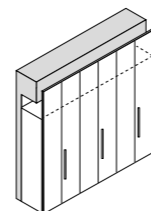

01

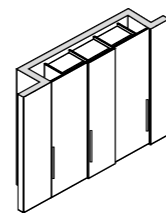

02



**Cabine armadio**  
**EN Walk-in closets**

# Sipario

## Modularità EN Modularity

P 42.3 - 59 cm  
L 47.8 - 57.8 - 67.8 - 97.8  
- 117.8 - 137.8 - 147.8 cm  
H 238.5 - 257.7 - 289.7 cm  
su misura

D 16.65" - 23.23"  
W 18.81" - 22.76" - 26.69"  
38.50" - 46.38" - 54.25"  
- 58.19"  
H 93.90" - 101.46" - 114.06"  
custom size

Accessori pag. 284  
EN Accessories pag. 284

## Finiture EN Finishes

Materico: Bianco,  
Borgogna, Canaletto,  
Rovere Laguna, Perlage  
Conchiglia, PerlageTerra

Laccato Opaco,  
EN Matt Lacquered

## Riduzioni su misura EN Made-to measure solutions

Vedi pag. 291,  
EN See pag. 291



I moduli cabina Sipario possono essere allestiti con tutti gli accessori interni previsti per i moduli armadio pag. 284. Possono essere abbinati a tutti i moduli di ante della collezione,

EN Sipario walk-in closet modules can be equipped with all internal accessories available for wardrobes on page 284. They can be combined with all the doors of the collection

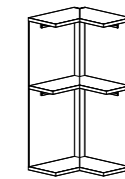
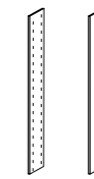
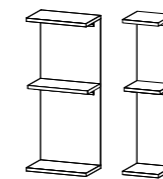
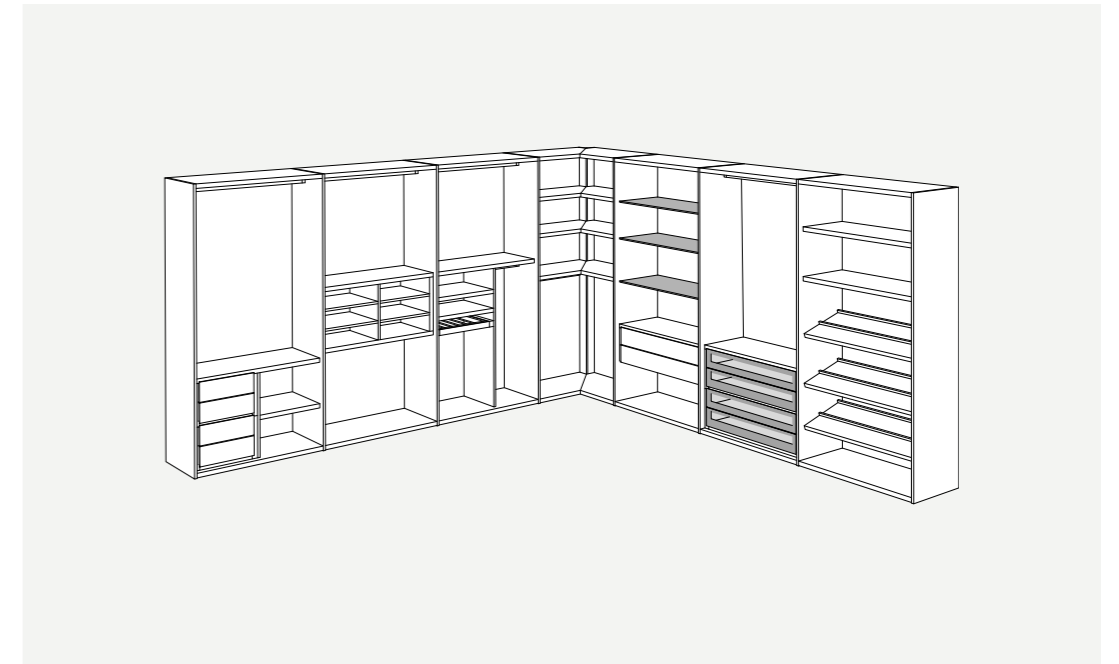

## Moduli EN Modules

L 47.8 - 57.8 - 67.8 - 97.8  
- 117.8 - 137.8 - 147.8 cm  
H 238.5 - 257.7 - 289.7 cm  
su misura

W 18.81" - 22.76" - 26.69"  
- 38.50" - 46.38" - 54.25"  
58.19"  
H 93.90" - 101.46" - 114.06"  
custom size

## Divisori EN Partitions

L 22 cm  
H 238.5 - 257.7 - 289.7 cm  
su misura

W 8.70"  
H 93.90" - 101.46" - 114.06"  
custom size

## Angolo EN Corner

L 94 x 94 cm - P 42.3 cm  
110.7 x 110.7 - P 59 cm  
H 238.5 - 257.7 - 289.7 cm  
su misura

W 37.01" x 37.01" - P 16.65"  
W 43.58" x 43.58" - P 23.23"  
H 93.90" - 101.46" - 114.06"  
custom size

# Sipario con telaio

## EN Sipario with frame

### Modularità

#### EN Modularity

P 42.3 - 59 cm  
L 47.8 - 57.8 - 67.8 - 97.8  
- 117.8 - 137.8 - 147.8 cm  
H 238.5 - 257.7 - 289.7 cm  
su misura

D 16.65" - 23.23"  
W 18.81" - 22.76" - 26.69"  
38.50" - 43.58 - 46.38" -  
54.25"  
H 93.90" - 101.46" - 114.06"  
custom size

Accessori pag. 284  
EN Accessories pag. 284

### Finiture

#### EN Finishes

Materico: Bianco,  
Borgogna, Canaletto,  
Rovere Laguna, Perlage  
Conchiglia, PerlageTerra

Laccato Opaco,  
EN Matt Lacquered

### Riduzioni su misura

#### EN Made-to measure solutions

Vedi pag. 291,  
EN See pag. 291



I moduli cabina Sipario possono essere allestiti con tutti gli accessori interni previsti per i moduli armadio pag. 284

EN Sipario walk-in closet modules can be equipped with all internal accessories available for wardrobes on page 284

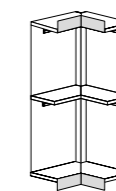
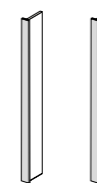
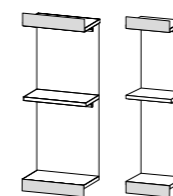
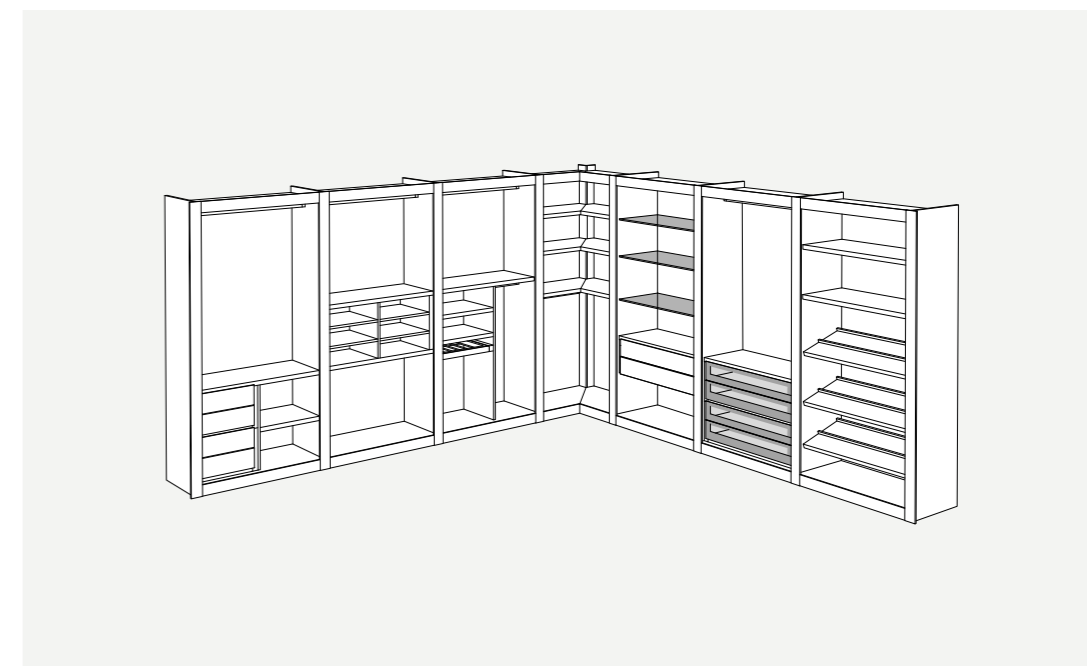

### Moduli

#### EN Modules

L 47.8 - 57.8 - 67.8 - 97.8  
- 117.8 - 137.8 - 147.8 cm  
H 238.5 - 257.7 - 289.7 cm  
su misura

W 18.81" - 22.76" - 26.69"  
- 38.50" - 46.38" - 54.25"  
58.19"  
H 93.90" - 101.46" - 114.06"  
custom size

### Divisori

#### EN Partitions

L 2.2 cm  
H 238.5 - 257.7 - 289.7 cm  
su misura

W 0.87"  
H 93.90" - 101.46" - 114.06"  
custom size

### Angolo

#### EN Corner

L 94 x 94 cm - P 42.3 cm  
110.7 x 110.7 - P 59 cm  
H 238.5 - 257.7 - 289.7 cm  
su misura

W 37.01" x 37.01" - P 16.65"  
W 43.58" x 43.58" - P 23.23"  
H 93.90" - 101.46" - 114.06"  
custom size

# Anteprima con schienali

## EN Anteprima with back panels

### Modularità

EN Modularity

L 50 - 70 - 90 - 110 cm  
H 238.5 - 257.7 - 289.7 cm

W 19.69" - 27.56" - 35.43"  
43.31"  
H 93.90" - 101.46" - 114.06"

Accessori pag. 284  
EN Accessories pag. 284

### Finiture

EN Finishes

Materico: Bianco,  
Borgogna, Canaletto,  
Rovere Laguna, Perlage  
Conchiglia, PerlageTerra

Laccato Opaco,  
EN Matt Lacquered

### Riduzioni su misura\*

EN Made-to measure solutions\*

Disponibili per cornici,  
schienali legno o specchio,  
ripiani, pedane e aste  
appendiabiti,  
EN Available for frames,  
wooden or mirror back  
panels, shelves, bases  
and hanging rods

\* Per limitazioni  
consultare il listino,  
EN For limitations please  
see pricelist

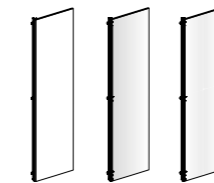
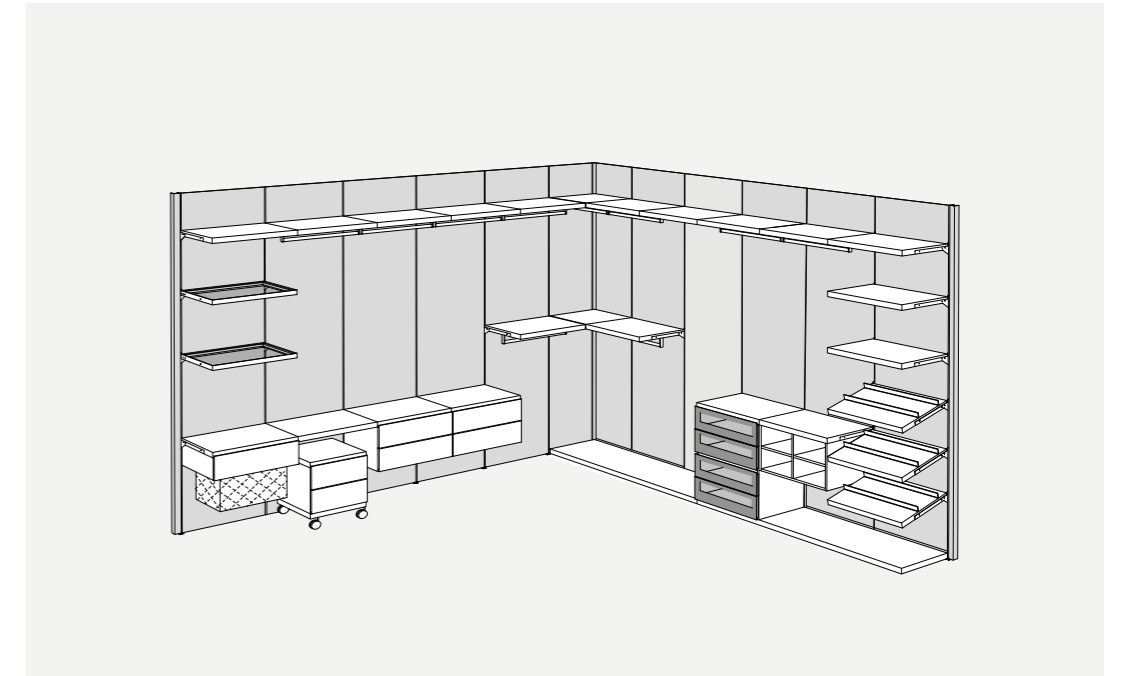

### Schienali

EN Back panels

L 50 - 70 - 90 - 110 cm  
H 238.5 - 257.7 - 289.7 cm

W 19.69" - 27.56" - 35.43"  
43.31"  
H 93.90" - 101.46" - 114.06"

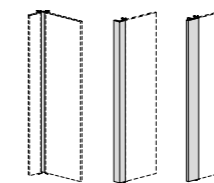

### Cornici ad L, lineari, ad angolo, EN L shaped, straight, corner frames

L 6 cm da 5 a 21 cm -  
10x10 cm  
H 238.5 - 257.7 - 289.7 cm

W 2.36" from 1.97" to  
8.27" - 3.94"x3.94"  
H 93.90" - 101.46" - 114.06"

# Anteprima senza schienali

## EN Anteprima without back panels

### Modularità

EN Modularity

L max 110 cm  
H 238.5 - 257.7 - 289.7 cm

W max 43.31"  
H 93.90" - 101.46" - 114.06"

Accessori pag. 284  
EN Accessories pag. 284

### Finiture montante

EN Vertical supports finishes

Alluminio pitturabile,  
EN Paintable aluminum,  
Manganese

### Riduzioni su misura

EN Made-to measure solutions

Disponibili per montanti ripiani, pedane e aste appendiabiti,  
EN Available for vertical supports, shelves, bases and hanging rods

\* Per limitazioni consultare il listino,  
EN For limitations please see pricelist

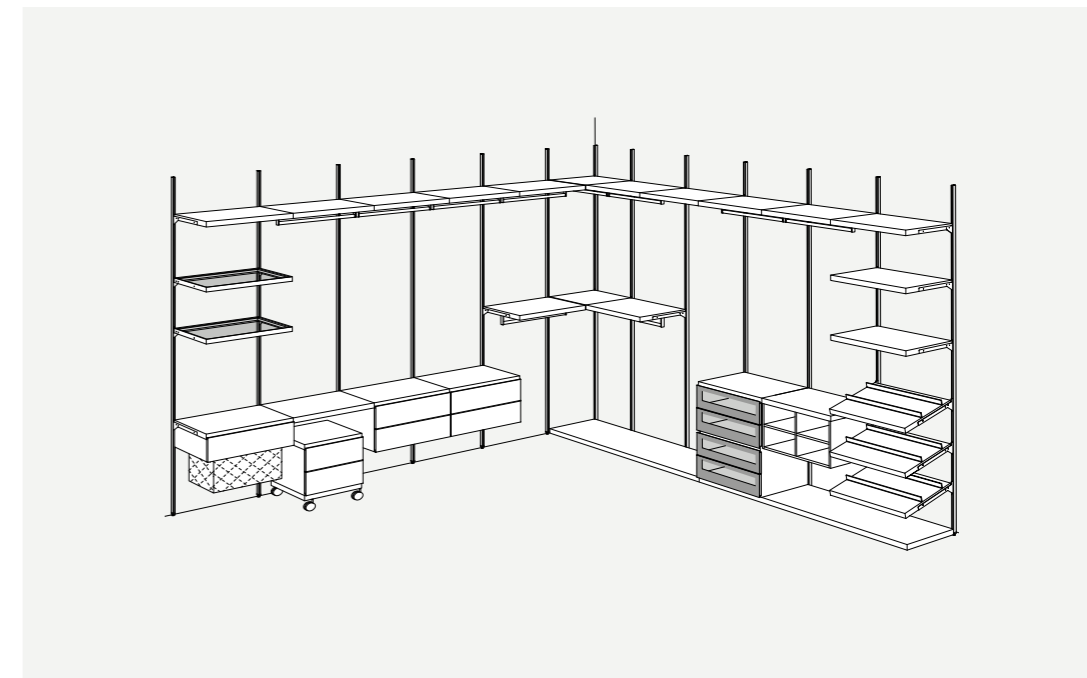

### Montanti

EN Vertical supports

H 238.5 - 257.7 - 289.7 cm  
H 93.90" - 101.46" - 114.06"

# Schienali

## EN Back panels

### Modularità EN Modularity

Sp 1 cm  
L 50 - 70 - 90 - 110 cm  
H 238.5 - 257.7 - 289.7 cm

Th 0.39"  
W 19.69" - 27.56" - 35.43"  
43.31"  
H 93.90" - 101.46" - 114.06"

### Tipologie EN Types

01

**Legno, EN Wood**  
Laccato Opaco,  
EN Matt Lacquered

Materico: Bianco,  
Borgogna, Canaletto,  
Rovere Laguna, Perlage  
Conchiglia, PerlageTerra

02

**Pelle Sintetica,  
EN Synthetic leather**  
Creta, Elephant, Talpa

03

**Vetro, EN Glass**  
Bianco retroilluminato,  
EN White back lit glass panel

04

**Vetro laccato Opaco o  
Lucido, EN Matt or Glossy**  
Lacquered glass  
Bronzo Metallizzato



01



02



03



04

### Tipologie EN Types

05

**Specchio, EN Mirror**  
Argento, Fumé, Piombo

06

**Materico:**  
Opaco o Lucido,  
EN Matt or Glossy:  
Gioia di carrara, Grafite,  
Emperador



05



06

# Ripiani e pedane con schienale

## EN Shelves and bases with back panel

### Tipologie EN Types

**01**  
Ripiano con staffe a vista,  
EN Shelf with visible  
supports

Sp 4 cm P 39.5 - 51 cm  
L min 14 - max 110 cm

Th 1.57" D 15.55" - 20.09"  
W min 5.51" max 43.31"



01

**02**  
Ripiano con staffe a  
scomparsa,  
EN Shelf with invisible  
supports

Sp 4 cm P 39.5 - 51 cm  
L min 14 max 300 cm

Th 1.57" D 15.55" - 20.09"  
W min 5.51" max 118.11"



03

**03**  
Ripiano portascarpe  
con staffe a vista,  
EN Shoe shelf with  
visible supports

P 39.5 - 51 cm  
L 50 - 70 - 90 - 110 cm

D 15.55" - 20.09"  
W 19.69" - 27.56" - 35.43"  
43.31"



**04**  
Ripiano portascarpe  
con staffe a scomparsa,  
EN Shoe shelf with  
invisible supports

P 39.5 - 51 cm  
L 50 - 70 - 90 - 110 cm

D 15.55" - 20.09"  
W 19.69" - 27.56" - 35.43"  
43.31"

310



02



04

### Tipologie EN Types

**05**  
Ripiano in vetro Fumé  
con telaio, EN Fumé glass  
shelf with frame  
Sp 3.5 cm Th 1.38"

P 39.5 - 51 cm  
L 50 - 70 - 90 - 110 cm

D 15.55" - 20.09"  
W 19.69" - 27.56" - 35.43"  
43.31"



05

**06**  
Pedane, EN Bases  
Sp 4 cm Th 1.57"

P 39.5 - 51.1 cm  
L min 14 max 300 cm

D 15.55" - 20.12"  
W min 5.51" max 118.11"

Non disponibile in Pelle  
Sintetica, EN Not available  
in Synthetic Leather



06

### Finiture EN Finishes

Laccato Opaco,  
EN Matt Lacquered

Materico: Bianco,  
Borgogna, Canaletto,  
Rovere Laguna, Perlage  
Conchiglia, PerlageTerra

Pelle Sintetica\*,  
EN Synthetic Leather\*:  
Creta, Elephant, Talpa

\* Solo per ripiani con  
staffe a vista, EN Only  
for shelves with visible  
supports

311

# Ripiani e pedane senza schienale

## EN Shelves and bases without back panel

### Tipologie EN Types

**01**  
Ripiano con staffe a vista,  
EN Shelf with visible  
supports

Sp 4 cm P 39.5 - 51 cm  
L min 14 - max 110 cm

Th 1.57" D 15.55" - 20.09"  
W min 5.51" max 43.31"



01

**02**  
Ripiano con staffe a  
scomparsa, EN Shelf with  
invisible supports

Sp 4 cm P 39.5 - 51 cm  
L min 14 max 300 cm

Th 1.57" D 15.55" - 20.09"  
W min 5.51" max 118.11"



03

**03**  
Ripiano portascarpe  
con staffe a vista,  
EN Shoe shelf with  
visible supports

P 39.5 - 51 cm  
L 50 - 70 - 90 - 110 cm

D 15.55" - 20.09"  
W 19.69" - 27.56" - 35.43"  
43.31"



**04**  
Ripiano portascarpe  
con staffe a scomparsa,  
EN Shoe shelf with  
invisible supports

P 39.5 - 51 cm  
L 50 - 70 - 90 - 110 cm

D 15.55" - 20.09"  
W 19.69" - 27.56" - 35.43"  
43.31"

312



02

### Tipologie EN Types

**05**  
Ripiano in vetro fumè  
con telaio, EN Fumé glass  
shelf with frame  
Sp 3.5 cm Th 1.38"

P 39.5 - 51 cm  
L 50 - 70 - 90 - 110 cm

D 15.55" - 20.09"  
W 19.69" - 27.56" - 35.43"  
43.31"



05

**06**  
Pedane, EN Bases  
Sp 4 cm Th 1.57"

P 39.5 - 51.1 cm  
L min 14 max 300 cm

D 15.55" - 20.12"  
W min 5.51" max 118.11"

Non disponibile in Pelle  
Sintetica, EN Not available  
in Synthetic Leather



06

### Finiture EN Finishes

Laccato Opaco,  
EN Matt Lacquered

Materico: Bianco,  
Borgogna, Canaletto,  
Rovere Laguna, Perlage  
Conchiglia, PerlageTerra

Pelle Sintetica\*,  
EN Synthetic Leather\*:  
Creta, Elephant, Talpa

\* Solo per ripiani con  
staffe a vista, EN Only  
for shelves with visible  
supports

313

# Cassettiere

## EN Drawer units

### Tipologie

#### EN Types

**01**  
Cassettiera autoportante,  
EN Floor sitting drawer unit



01

**02**  
Cassettiera autoportante  
con ruote, EN Free standing  
drawer unit on castors



02

**03**  
Cassettiera pensile,  
EN Suspended drawer unit



03

**04**  
Cassettiera sottopiano,  
EN Under shelf drawer  
unit



04

# Frontali cassetti

## EN Drawer fronts

### Tipologie

#### EN Types

**01**  
Legno, EN Wood  
H 18 - 36 cm  
H 7.09" - 14.17"



01

**02**  
Vetro, EN Glass  
H 18 - 36 cm  
H 7.09" - 14.17"



02

**03**  
Con oblò, EN See-through  
glass front  
H 18 cm - H 7.09"



03

**04**  
Pelle sintetica,  
EN Synthetic leather



04

### Finiture

#### EN Finishes

Materico: Bianco,  
Borgogna, Canaletto,  
Rovere Laguna, Perlage  
Conchiglia, PerlageTerra

Laccato Opaco,  
EN Matt Lacquered

Vetro, EN Glass:  
Laccato Opaco o Lucido,  
EN Matt or Glossy  
Lacquered

Con oblò, EN See-through  
glass front:  
Extrachiaro Trasparente  
con cornice Bianco, Fumé  
con cornice Nero,  
EN Extrachiaro Trasparente  
with White frame, Fumé  
with Black frame

Pelle Sintetica  
EN Synthetic Leather:  
Creta, Elephant, Talpa

# Cassettiere autoportanti

## EN Floor sitting drawer units

### Modularità EN Modularity

L 50 - 70 - 90 - 110 cm  
P 41.5\* - 53.3 cm  
H 44 - 82 cm

W 19.69" - 27.56" - 35.43"  
43.31"  
D 16.34"\* - 20.98"  
H 17.32" - 32.28"

**H 44 cm - 17.32"**  
1 Cestone, EN Tall drawer

2 Cassetti, EN Drawers

2 Cassetti con oblò,  
EN Drawers with  
see-through glass front

**H 82 cm - 32.28"**  
2 Cestoni, EN Tall drawers

2 Cassetti + 1 Cestone,  
EN 2 Drawers + 1 Tall drawer

4 Cassetti, EN Drawers

4 Cassetti con oblò,  
EN Drawers with  
see-through glass front

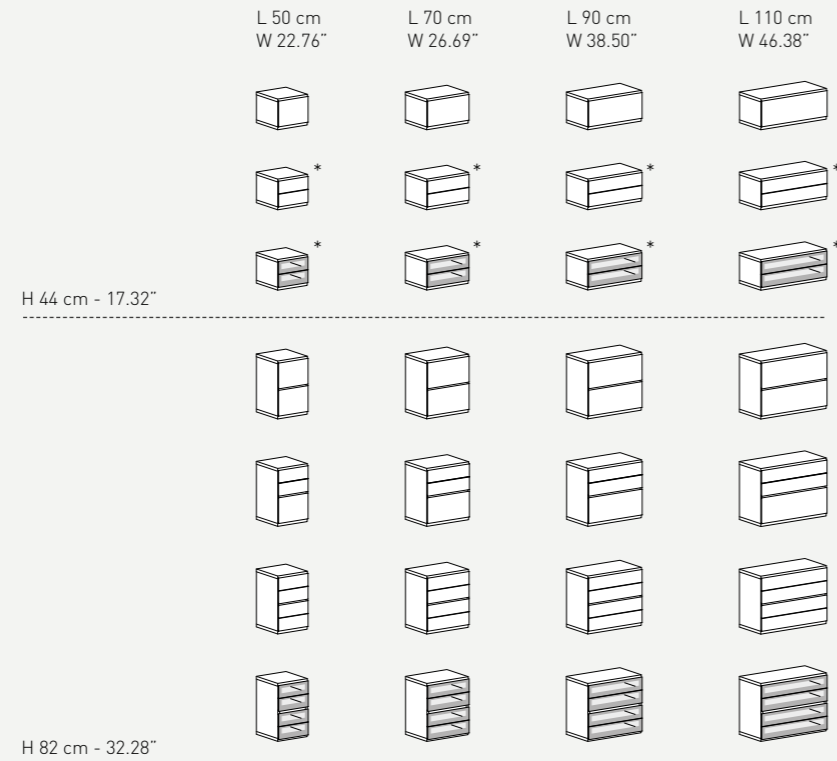

H 44 cm - 17.32"

H 82 cm - 32.28"

# Cassettiere sottopiano

## EN Under shelf drawer units

### Modularità EN Modularity

L 50 - 70 - 90 - 110 cm  
P 41.5\* - 53.3 cm

W 19.69" - 27.56" - 35.43"  
43.31" D 16.34"\* - 20.98"

**H 35.2 cm - 13.86"**  
1 Cestone, EN Tall drawer

2 Cassetti, EN Drawers

2 Cassetti con oblò,  
EN Drawers with  
see-through glass front

**H 52.8 cm - 20.79"**  
2 Cestoni, EN Tall drawers

2 Cassetti + 1 Cestone,  
EN 2 Drawers + 1 Tall drawer

4 Cassetti, EN Drawers

4 Cassetti con oblò,  
EN Drawers with  
see-through front

**H 70.4 cm - 27.72"**  
3 Cestoni, EN Tall drawer 6  
Cassetti, EN Drawers

2 Cassetti + 2 Cestoni,  
EN 2 Drawers + 2 Tall drawers

4 Cassetti + 1 Cestone,  
EN 4 Drawers + 1 Tall drawer

6 Cassetti, EN Drawers

6 Cassetti con oblò,  
EN Drawers with  
see-through glass front

Le cassettiere sottopiano  
devono essere completate  
con un ripiano superiore  
di chiusura e con una  
pedana inferiore, EN Under  
shelf drawer units must  
always have a finishing  
top shelf as well as a floor  
sitting base

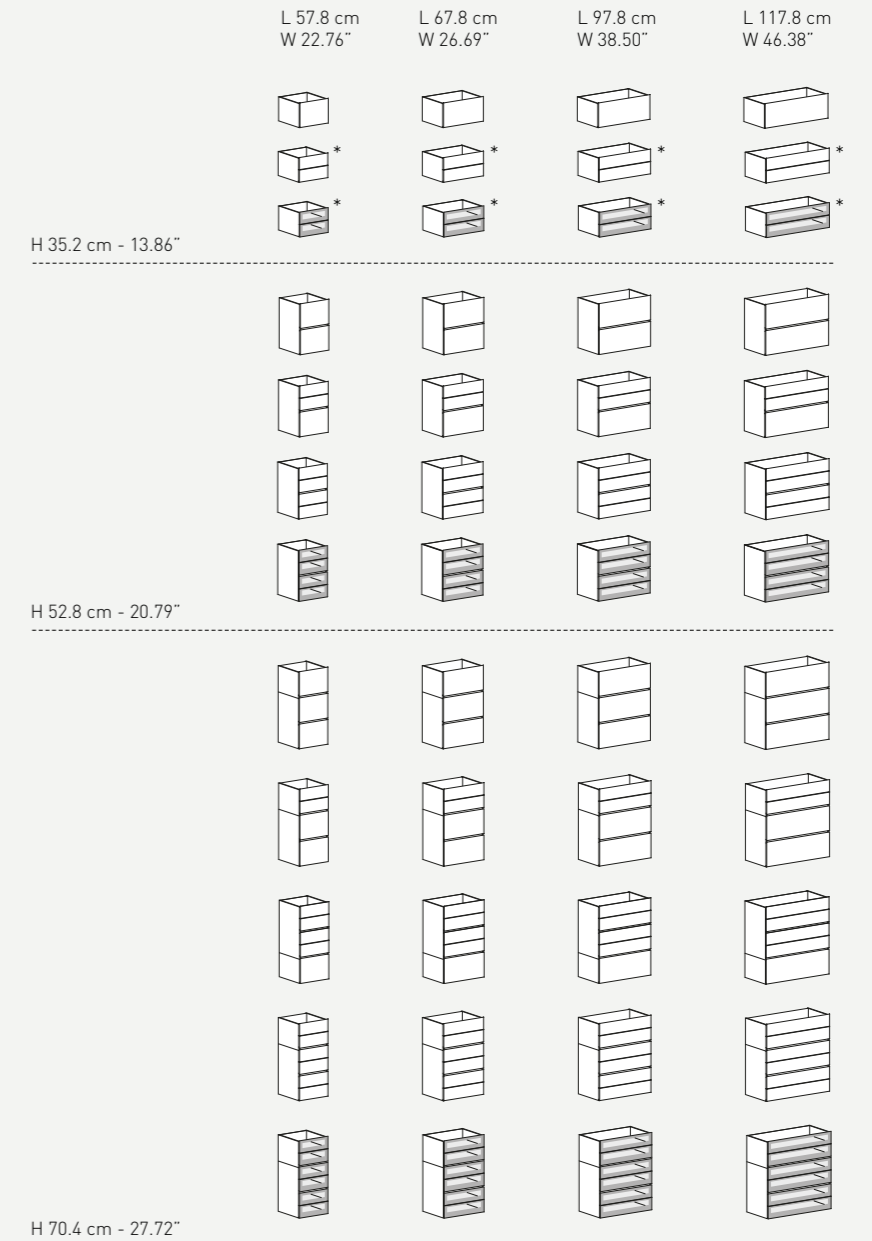

H 35.2 cm - 13.86"

H 52.8 cm - 20.79"

H 70.4 cm - 27.72"

# Cassettiere pensili

## EN Suspended drawer units

### Modularità EN Modularity

L 50 - 70 - 90 - 110 cm  
P 41.5\* - 53 cm

W 19.69" - 27.56" - 35.43"  
43.31"  
D 16.34"\* - 20.87"

#### H 17 cm - 6.69"

1 Cassetto, EN Drawer

1 Cassetto con oblò,  
EN Drawer with  
see-through glass front

#### H 38 cm - 14.96"

1 Cestone, EN Tall drawer

2 Cassetti, EN Drawers

1 Cassetti con oblò,  
EN Drawers with  
see-through glass front

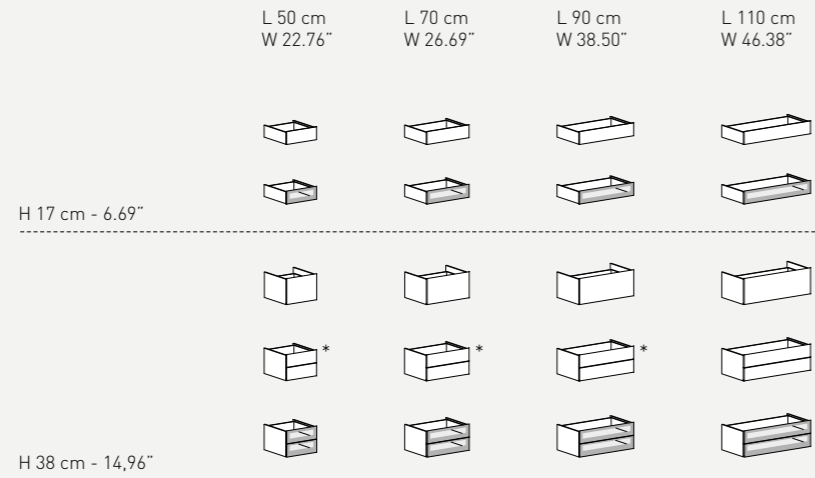

Le cassettiere pensili  
devono essere  
completate con un  
ripiano superiore di  
chiusura,  
EN Suspended drawer  
units must always have a  
finishing top shelf

# Raster pensili

## EN Suspended cubbies

### Modularità EN Modularity

L 50 - 70 - 90 - 110 cm  
P 41.5 - 51.1 cm  
H 36 - 53 - 71 cm

W 19.69" - 27.56" - 35.43"  
43.31"  
D 16.34" - 20.12"  
H 14.17" - 20.87" - 27.95"

#### Contenitori per raster, EN Boxes for cubbies

L 31.2 - 41.2 - 45 - 51.2 cm  
P 50.5 cm  
H 14 cm

W 12.28" - 16.22" - 17.72"  
- 20.16"  
D 19.88"  
H 5.51"

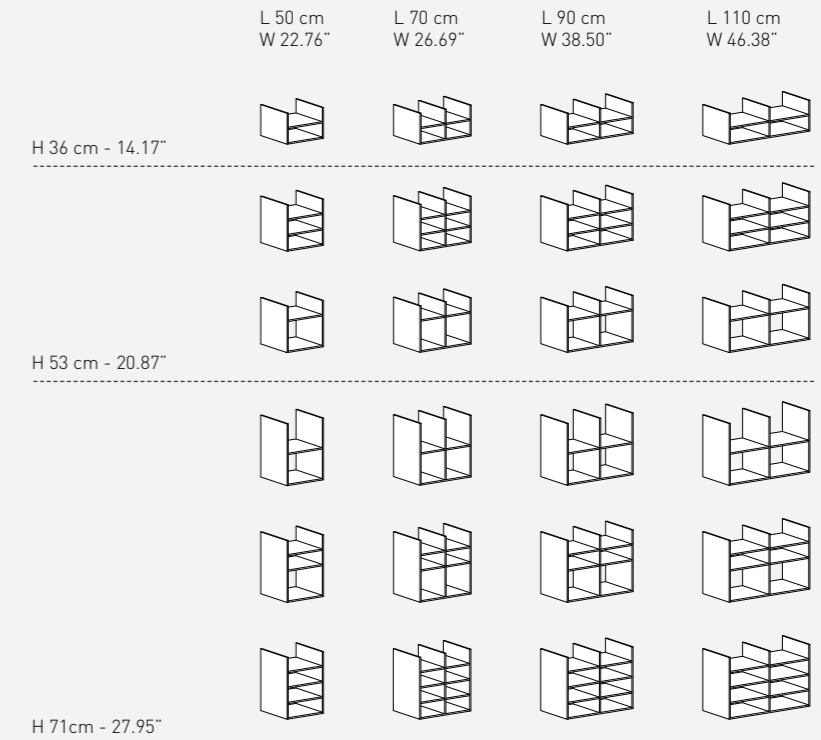

# Telai estraibili e accessori

## EN Pull-out frames and accessories

### Tipologie EN Types

**01**  
Vassoio metallo,  
EN Metal tray

H 6 cm - 2.36"  
Finitura, EN Finish  
Manganese

**02**  
Piano vetro Fumé,  
EN Fumé glass shelf

H 6 cm - 2.36"

**03**  
Piano in legno,  
EN Wooden shelf

H 6 cm - 2.36"  
Finiture, EN Finishes  
Materico: Bianco,  
Borgogna, Canaletto,  
Rovere Laguna, Perlage  
Conchiglia, PerlageTerra

Laccato Opaco,  
EN Matt lacquered

**04**  
Griglia per vassoio,  
EN Grid for tray

H 6 cm - 2.36"  
Finitura, EN Finish  
Manganese

**05**  
Portapantaloni + vaschetta,  
non disponibile L 70 cm  
EN Trousers rack + tray,  
not available W 27.56"

H 6 cm - 2.36"  
Finitura, EN Finish  
Manganese



01



02



03



04



05



06

### Tipologie EN Types

**06**  
Portapantaloni +  
portagonna non  
disponibile L 70 cm,  
EN Trousers + skirt rack  
not available W 27.56"

H 6 cm - 2.36"  
Finitura, EN Finish  
Manganese

**07**  
Portapantaloni,  
EN Trousers rack

H 6 cm - 2.36"  
Finitura, EN Finish  
Manganese

**08**  
Portagonne, EN Skirt rack

H 6 cm - 2.36"  
Finitura, EN Finish  
Manganese

**09**  
Scarpiera in metallo,  
EN Metal shoe rack

H 15 cm - 5.91"

Finitura, EN Finish  
Manganese

**10**  
Sacche portabiancheria  
in tessuto trapuntato,  
EN Hampers in tufted  
fabric

H 31 cm - 12.20"



06



07



08



09

**Complementi cabine**  
**EN Walk-in closet complements**

# Island

## Modularità, EN Modularity

L 144 - 184 - 224 cm  
H 85 cm  
P 58 - 107 cm

W 56.69" - 72.44" - 88.19"  
H 33.46"  
D 22.83" - 42.13"

## Finiture, EN Finishes

Materico: Bianco,  
Borgogna, Canaletto,  
Rovere Laguna, Perlage  
Conchiglia, PerlageTerra

Laccato Opaco,  
EN Matt Lacquered

## Frontali cassetti, EN Drawer frontals

Materico: Bianco,  
Borgogna, Canaletto,  
Rovere Laguna, Perlage  
Conchiglia, PerlageTerra

Laccato Opaco,  
EN Matt Lacquered

Pelle Sintetica  
EN Synthetic Leather:  
Creta, Elephant, Talpa



## Attrezzabilità EN Accessories

Il modulo può essere  
completato con la teca  
superiore in vetro, con  
vassoi rivestiti nelle  
diverse conformazioni,  
con telai estraibili  
completi di accessori  
(vassoio in metallo, piano  
in legno materico o vetro  
fumè trasparente) e  
serratura elettronica,

EN The module can be  
supplied with a glass top  
display case, with lined  
trays available in various  
configurations, with  
pull-out trays completed  
with accessories for the  
drawer's interior (metal  
tray, wood or transparent  
Fumé glass shelf) and the  
electronic lock

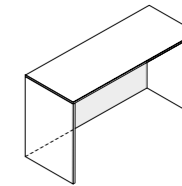

## Struttura con schienale EN Structure with back

L 144 - 184 - 224 cm  
H 85 cm  
P 58 cm

W 56.69" - 72.44" - 88.19"  
H 33.46"  
D 22.83"

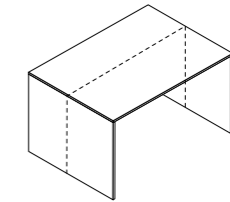

## Struttura doppia EN Double structure

L 144 - 184 - 224 cm  
H 85 cm  
P 107 cm

W 56.69" - 72.44" - 88.19"  
H 33.46"  
D 42.13"

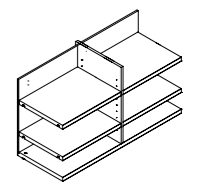

## Vano con ripiani EN Shelves

L 140 - 180 - 220 cm  
H 83 cm  
P 53 cm

W 55.12" - 72.44" - 88.19"  
H 33.46"  
D 20.87"

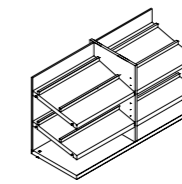

## Vano con portascarpe EN Shoe shelves

L 140 - 180 - 220 cm  
H 83 cm  
P 53 cm

W 55.12" - 72.44" - 88.19"  
H 33.46"  
D 20.87"

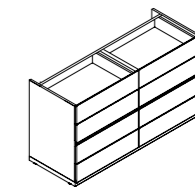

## Vano con cassetti EN Drawers

L 140 - 180 - 220 cm  
H 83 cm  
P 53 cm

W 55.12" - 72.44" - 88.19"  
H 33.46"  
D 20.87"

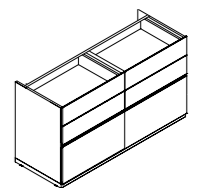

## Vano con cassetto e cestone, EN Drawers + tall drawer

L 140 - 180 - 220 cm  
H 83 cm  
P 53 cm

W 55.12" - 72.44" - 88.19"  
H 33.46"  
D 20.87"

# Island accessori

## EN Island accessories

### Finiture EN Finishes

### Teca, EN Display case

Vetro trasparente,  
EN Transparent glass

### Vassoi, EN Trays

Pelle Sintetica,  
EN Synthetic Leather  
Creta, Elephant

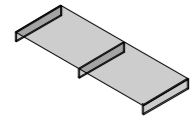

#### Teca singola EN Half glass display case

L 144 - 184 - 224 cm  
H 10 cm  
P 58 cm

W 56.69" - 72.44" - 88.19"  
H 3.94"  
D 22.83"

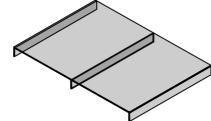

#### Teca doppia EN Glass display case

L 144 - 184 - 224 cm  
H 10 cm  
P 107 cm

W 56.69" - 72.44" - 88.19"  
H 3.94"  
D 42.13"

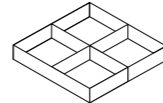

#### Vassoio tipo A singolo EN Half tray type A

L 70 - 90 - 110 cm  
H 6 cm  
P 57 cm

W 27.56" - 35.95" - 43.31"  
H 2.36"  
D 22.44"

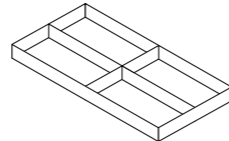

#### Vassoio tipo A doppio EN Double tray type A

L 70 - 90 - 110 cm  
H 6 cm  
P 106 cm

W 27.56" - 35.95" - 43.31"  
H 2.36"  
D 41.73"

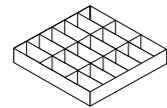

#### Vassoio tipo B singolo EN Half tray type B

L 70 - 90 - 110 cm  
H 6 cm  
P 57 cm

W 27.56" - 35.95" - 43.31"  
H 2.36"  
D 22.44"

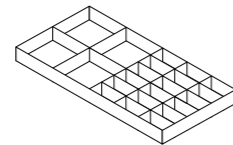

#### Vassoio tipo B doppio EN Double tray type B

L 70 - 90 - 110 cm  
H 6 cm  
P 57 cm

W 27.56" - 35.95" - 43.31"  
H 2.36"  
D 22.44"

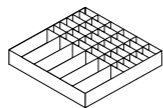

#### Vassoio tipo C singolo EN Half tray type C

L 70 - 90 - 110 cm  
H 6 cm  
P 57 cm

W 27.56" - 35.95" - 43.31"  
H 2.36"  
D 22.44"

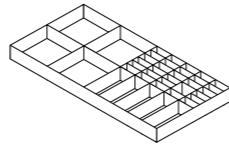

#### Vassoio tipo C doppio EN Double tray type C

L 70 - 90 - 110 cm  
H 6 cm  
P 57 cm

W 27.56" - 35.95" - 43.31"  
H 2.36"  
D 22.44"

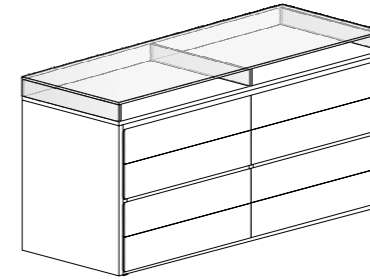

#### Modulo singolo con cassetti e teca superiore, EN Single unit with drawers and glass display case

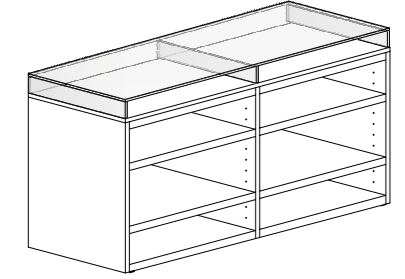

#### Modulo singolo con ripiani e teca superiore, EN Single unit with shelves and glass display case

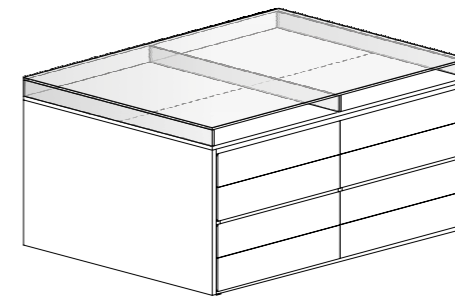

#### Modulo doppio con cassetti e teca superiore, EN Double unit with drawers and glass display case

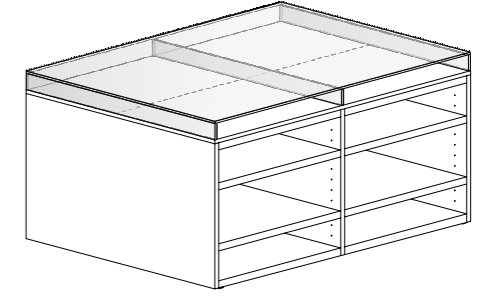

#### Modulo doppio con ripiani e teca superiore, EN Double unit with shelves and glass display case

# Snake

## Finiture EN Finishes

Acciaio spazzolato,  
EN Brushed steel



Le dimensioni a passo 14 cm danno la possibilità di creare qualsiasi disegno a parete,  
EN Thanks to 5.51" pitch virtually any wall configuration is possible

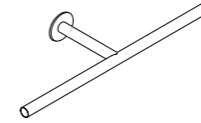

### Tubi lineari EN Straight pipes

L 60 - 74 - 88 - 102 - 116  
130 - 144 - 158 - 172 - 200 cm  
P 27 cm Ø 3.5 cm  
Portata 20 kg distribuito  
al ml

W 23.62" - 29.13" - 34.65"  
- 40.16 - 45.67" - 51.18"  
- 56.69" - 62.20" - 67.72"  
- 78.74"  
D 10.63" Ø 1.38"  
Max 20 kg per linear  
meter evenly distribute



### Connessione lineare EN Straight junction

L 10 cm Ø 3.5 cm  
W 3.94" Ø 1.38"

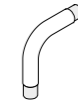

### Connessione a L EN L junction

L 14 H 14 Ø 3.5 cm  
W 5.51" H 5.51" Ø 1.38"

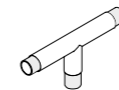

### Connessione a T EN T junction

L 24 H 14 Ø 3.5 cm  
W 9.45" H 5.51" Ø 1.38"

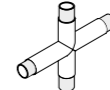

### Connessione a croce EN Cross junction

L 24 H 24 cm Ø 3.5 cm  
W 9.45" H 9.45" Ø 1.38"



### Terminale a parete EN Wall terminal

L 14 cm P 27 cm Ø 3.5 cm  
W 5.51" D 10.63" Ø 1.38"

# Vista sistema di chiusura

## EN Vista door system

Il sistema di chiusura Vista si caratterizza per la totale assenza di telai e per la modularità al millimetro. Binari e ante vengono sempre realizzati su misura,

EN A characteristic of the Vista door system is the absence of frames and the extremely wide modularity. Rails and doors are always made to measure

### Binario monorotaia

#### EN Single track

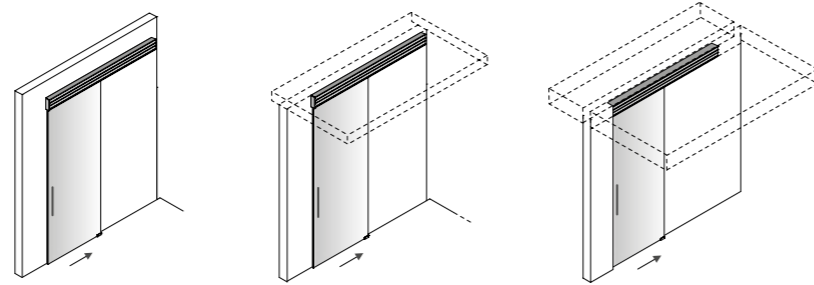

#### A parete,

##### EN Wall mounted

L min 135 max 600 cm  
W min 53.15" max 236.22"

#### A soffitto,

##### EN Ceiling mounted

L min 135 max 600 cm  
W min 53.15" max 236.22"

#### Ad incasso,

##### EN Recessed

L min 135 max 600 cm  
W min 53.15" max 236.22"

### Binario monorotaia + pannello fisso

#### EN Single track + fixed panel

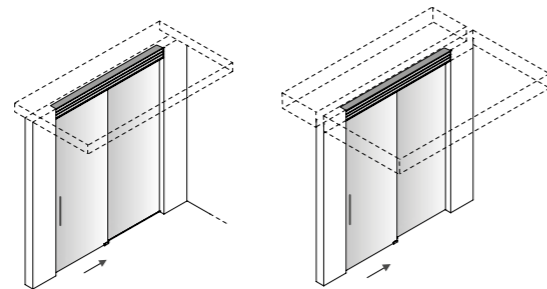

#### A soffitto,

##### EN Ceiling mounted

L min 138 max 600 cm  
W min 54.33" max 236.22"

#### Ad incasso,

##### EN Recessed

L min 138 max 600 cm  
W min 54.33" max 236.22"

### Binario birotaia

#### EN Double track

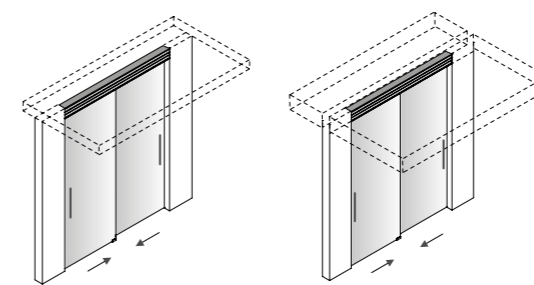

#### A soffitto,

##### EN Ceiling mounted

L min 138 max 600 cm  
W min 54.33" max 236.22"

#### Ad incasso,

##### EN Recessed

L min 138 max 600 cm  
W min 54.33" max 236.22"

### Pannelli fissi divisori

#### EN Fixed panels dividers

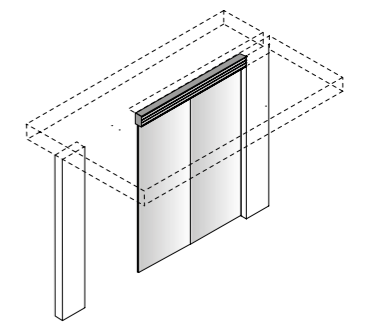

#### Pannello fisso divisorio,

##### EN Fixed panel divider

L min 70 max 600 cm  
W min 27.56" max 236.22"

### Angolari

#### EN Corner

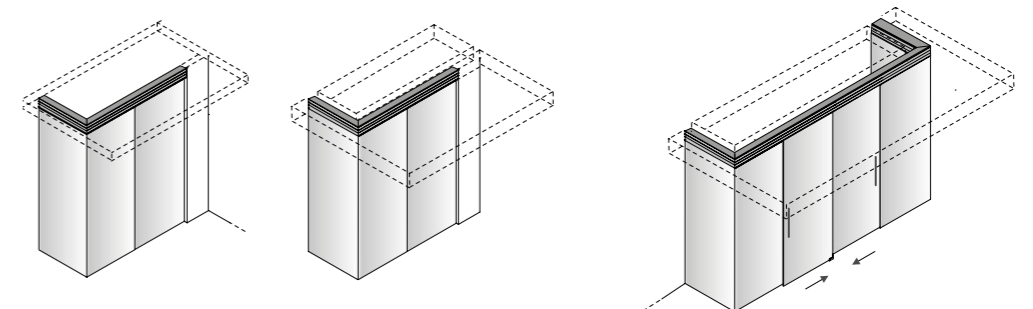

#### Pannello fisso soffitto,

##### EN Ceiling mounted fixed panel

L min 70 max 600 cm  
W min 27.56" max 236.22"

#### Pannello fisso ad incasso,

##### EN Recessed fixed panel

L min 70 max 600 cm  
W min 27.56" max 236.22"

#### 2 pannelli fissi e 2 ante su binario birotaia a soffitto,

##### EN 2 fixed panels and 2 doors on recessed double track

L min 70 max 600 cm  
W min 27.56" max 236.22"

# Vista con anta Crystal

## EN Vista with Crystal door

### Finiture EN Finishes

#### Finiture anta, EN Door finishes

Vetro, <sup>EN</sup> Glass:  
Laccato Opaco o Lucido,  
<sup>EN</sup> Matt or Glossy  
Lacquered

Fumé Trasparente,  
Trama Argento, Trama  
Bronzo, Trama Fumé

#### Finiture Binario, EN Track Finishes

Alluminio Anodizzato o  
pitturabile con tempere  
murarie, <sup>EN</sup> Anodised or  
paintable aluminum

### Maniglie EN Handles

Con Gola, <sup>EN</sup> With groove  
U40

Finiture Metallo,  
<sup>EN</sup> Metal Finishes:  
Bronzo, Cromo, Oro,  
Rame, Titanio

Laccato Opaco,  
<sup>EN</sup> Matt Lacquered



### Modularità EN Modularity

L da 70 a 120 cm  
H da 190 a 280 cm

W from 27.56" to 47.24"  
H from 74.80" to 110.24"

#### Pannello fisso, EN Fixed panel

L da 70 a 120 cm  
H da 190 a 280 cm

W from 27.56" to 47.24"  
H from 74.80" to 110.24"

#### Binario di scorrimento, EN Track

L max 600 cm  
W max 236.22"

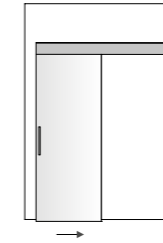

#### Anta scorrevole con binario a parete, EN Sliding door with wall mounted track

Dimensione vano,  
<sup>EN</sup> Opening:

L da 68 a 118 cm  
H da 186 a 276 cm

W from 26.77" to 46.46"  
H from 73.22" to 108.66"

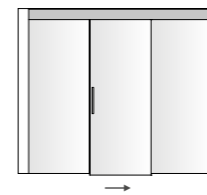

#### Anta scorrevole e 2 pannelli fissi binario a soffitto, <sup>EN</sup> Door and 2 fixed panels on a ceiling mounted track

Dimensione vano,  
<sup>EN</sup> Opening:

L da 206 a 356 cm  
H da 199 a 289 cm

W from 81.10" to 140.16"  
H from 78.35" to 113.78"

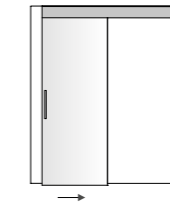

#### Anta scorrevole con binario a soffitto, EN Sliding door with ceiling mounted track

Dimensione vano,  
<sup>EN</sup> Opening:

L da 68 a 118 cm  
H da 199 a 289 cm

W from 26.77" to 46.46"  
H from 78.35" to 113.78"

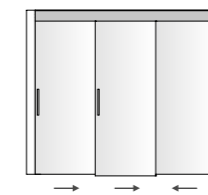

#### 3 ante scorrevoli con binario a soffitto, EN 3 sliding doors with ceiling mounted track

Dimensione vano,  
<sup>EN</sup> Opening:

L da 206 a 356 cm  
H da 199 a 289 cm

W from 81.10" to 140.16"  
H from 78.35" to 113.78"

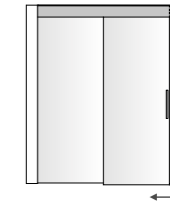

#### Anta scorrevole e pannello fisso con binario a soffitto, EN Door and fixed panel on ceiling mounted track

Dimensione vano,  
<sup>EN</sup> Opening:

L da 138 a 238 cm  
H da 199 a 289 cm

W from 54.33" to 93.70"  
H from 78.35" to 113.78"

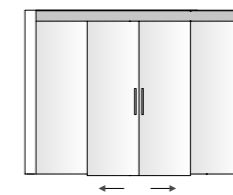

#### 2 ante scorrevoli e 2 pannelli fissi binario a soffitto, <sup>EN</sup> 2 sliding doors and 2 fixed panels on a ceiling mounted track

Dimensione vano,  
<sup>EN</sup> Opening:

L da 276 a 476 cm  
H da 199 a 289 cm

W from 108.66" to 187.40"  
H from 78.35" to 113.78"

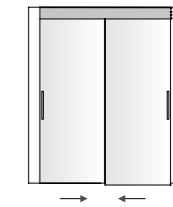

#### 2 ante scorrevoli con binario a soffitto, EN 2 sliding doors with ceiling mounted track

Dimensione vano,  
<sup>EN</sup> Opening:

L da 138 a 238 cm  
H da 199 a 289 cm

W from 54.33" to 93.70"  
H from 78.35" to 113.78"

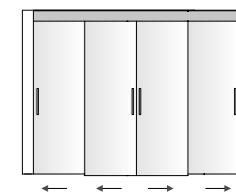

#### 4 ante scorrevoli binario a soffitto, EN 4 sliding doors on a ceiling mounted track

Dimensione vano,  
<sup>EN</sup> Opening:

L da 276 a 476 cm  
H da 199 a 289 cm

W from 108.66" to 187.40"  
H from 78.35" to 113.78"

# Vista con anta Plana

## EN Vista with Plana door

### Finiture EN Finishes

#### Finiture anta, EN Door finishes

Laccato Opaco o Lucido,  
Alaska Laccato, EN Matt  
or High Gloss Lacquered,  
Alaska Lacquered

Soft touch

Essenza, EN Wood:  
Borgogna, Canaletto,  
Rovere Fumo, Rovere  
Grigio, Rovere Laguna  
Rovere Naturale, Rovere  
Tabacco

Materico: Bianco, Cenere,  
Seta, Alaska, Corsica

Pitturabile con tempere  
murarie, EN Paintable

#### Finiture Binario, EN Track Finishes

Alluminio Anodizzato o  
pitturabile con tempere  
murarie, EN Anodised  
aluminum, paintable  
aluminum

### Maniglie EN Handles

U40

Finiture Metallo,  
EN Metal Finishes:  
Bronzo, Cromo, Oro,  
Rame, Titanio

Laccato Opaco,  
EN Matt Lacquered



### Modularità EN Modularity

L da 70 a 120 cm  
H da 190 a 280 cm

W from 27.56" to 47.24"  
H from 74.80" to 110.24"

#### Pannello fisso, EN Fixed panel

L da 70 a 120 cm  
H da 190 a 280 cm

W from 27.56" to 47.24"  
H from 74.80" to 110.24"

#### Binario di scorrimento, EN Track

L max 600 cm  
W max 236.22"

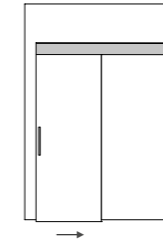

#### Anta scorrevole con binario a parete, EN Sliding door with wall mounted track

Dimensione vano,  
EN Opening:

L da 68 a 118 cm  
H da 186 a 276 cm

W from 26.77" to 46.46"  
H from 73.22" to 108.66"

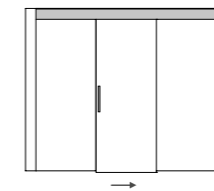

#### 3 ante scorrevoli con binario a soffitto, EN 3 sliding doors with ceiling mounted track

Dimensione vano,  
EN Opening:

L da 206 a 356 cm  
H da 199 a 289 cm

W from 81.10" to 140.16"  
H from 78.35" to 113.78"

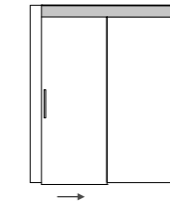

#### Anta scorrevole con binario a soffitto, EN Sliding door with ceiling mounted track

Dimensione vano,  
EN Opening:

L da 68 a 118 cm  
H da 199 a 289 cm

W from 26.77" to 46.46"  
H from 78.35" to 113.78"

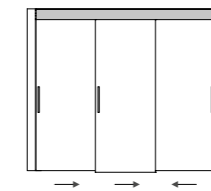

#### Anta scorrevole e 2 pannelli fissi binario a soffitto, EN Sliding doors and 2 fixed panels on a ceiling mounted track

Dimensione vano,  
EN Opening:

L da 206 a 356 cm  
H da 199 a 289 cm

W from 81.10" to 140.16"  
H from 78.35" to 113.78"

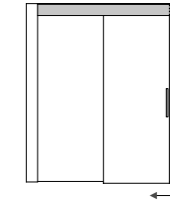

#### Anta scorrevole e pannello fisso con binario a soffitto, EN Sliding door and fixed panel on ceiling mounted track

Dimensione vano,  
EN Opening:

L da 138 a 238 cm  
H da 199 a 289 cm

W from 54.33" to 93.70"  
H from 78.35" to 113.78"

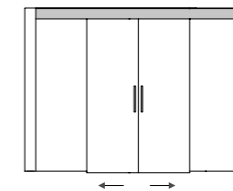

#### 2 ante scorrevoli e 2 pannelli fissi binario a soffitto, EN 2 sliding doors and 2 fixed panels on a ceiling mounted track

Dimensione vano,  
EN Opening:

L da 276 a 476 cm  
H da 199 a 289 cm

W from 108.66" to 187.40"  
H from 78.35" to 113.78"

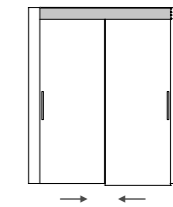

#### 2 ante scorrevoli con binario a soffitto, EN 2 sliding doors with ceiling mounted track

Dimensione vano,  
EN Opening:

L da 138 a 238 cm  
H da 199 a 289 cm

W from 54.33" to 93.70"  
H from 78.35" to 113.78"

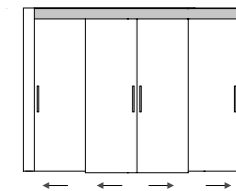

#### 4 ante scorrevoli binario a soffitto, EN 4 sliding doors on a ceiling mounted track

Dimensione vano,  
EN Opening:

L da 276 a 476 cm  
H da 199 a 289 cm

W from 108.66" to 187.40"  
H from 78.35" to 113.78"

## PIANCA

Via dei Cappellari, 20  
31018 – Gaiarine, Treviso  
ITALY

T +39 0434 756911  
F +39 0434 75330

info@pianca.com  
pianca.com

p.iva IT 01682580269

Set design

**Calvi Brambilla**

Styling

**Elena Caponi Studio**

Artwork

**Emilio Nanni**

Graphic Design

**makethatstudio**

Photography & Renderings

**NudesignStudio**

Copywriting

**Silvia Perrini**

Printed

**Sincromia** COD.181111

Settembre, 2018

Vietata la riproduzione a qualsiasi scopo.

Campione promozionale gratuito non destinato alla vendita.  
Escluso iva art.2 comma 3 D.P.R. 633/72 - esonerato da documento di trasporto art.4 punto 6 D.P.R. 627/78

Pianca si riserva di apportare, senza preavviso, le modifiche necessarie al fine di migliorare il funzionamento e la qualità dei propri prodotti. Si prega di consultare i listini e relativi aggiornamenti per aspetti tecnici e dimensionali. Colori e materiali hanno valore puramente rappresentativo.

<sup>EN</sup> Pianca reserves the right to apply the necessary modifications without notice, in order to improve the performance and quality of its products. Please see the pricelists and relevant updates for technical data and dimensions. Colours and materials serve merely as an example.

Thanks to

**Agustina Bottoni, Andrea Cardone, Artemide, Astep, Astrid Luglio per Tonatto Profumi, AYTM, Bibi Smit, Birgit Severin, Cristina Celestino, Daandesign, Dechem, Diego Zanella, Duecitti, Edizioni Design, Feelomena, Ferruccio De Vecchi, Ginevra Taccola, Giunone Couture, Ibrigu, Il Fanale, IL Independent Label, Jcp Design, Jeremie Duprey, Kristina Dam, Kundalini, Maatroom, Maniceramics, Matthias Kaiser, MMLampadari, Nahoor, Natascha Madeiski, Petite Friture, Philippe Tabet, Portego, Pulpo, Rodo since 1956, Sandra Davolio, Serena Confalonieri, Vanessa Mitrani, Verreum**

Works of art

**Lorenzo Mazza,  
Ivan De Menis, courtesy of Project B Gallery**

PIANCA azienda certificata FSC®



**Il marchio della  
gestione forestale  
responsabile**

Cerca i prodotti certificati FSC®

Studija - Amatciems

Stabu iela 119

Rīga, LV-1009

+371 28647050

[info@studija-amatciems.lv](mailto:info@studija-amatciems.lv)

[www.studija-amatciems.lv](http://www.studija-amatciems.lv)